

MHI

DATA BOOK

DRAFT

Manual No.'09•SRK-DB-087D

INVERTER WALL MOUNTED TYPE ROOM AIR-CONDITIONERS (Split system, air to air heat pump type)

SRK20ZJ-S
25ZJ-S
35ZJ-S

CONTENTS

1	SPECIFICATIONS	2
2	EXTERIOR DIMENSIONS	5
3	ELECTRICAL WIRING	7
4	NOISE LEVEL	9
5	PIPING SYSTEM	12
6	APPLICATION DATA	13
	(1) Installation of indoor unit	13
	(2) Installation of outdoor unit	17
7	RANGE OF USAGE & LIMITATIONS	24
8	CAPACITY TABLES	26

REFERENCE

1	OUTLINE OF OPERATION CONTROL BY MICROCOMPUTER	27
2	TROUBLESHOOTING PROCEDURES FOR ELECTRICAL EQUIPMENT	39

How to read the model name

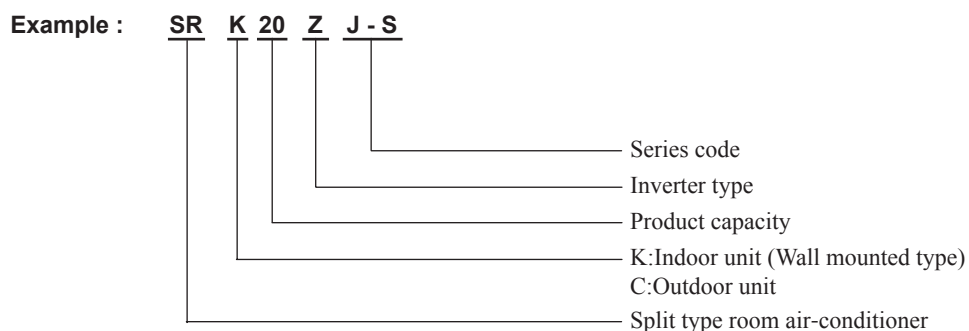

1 SPECIFICATIONS

Adapted to RoHS directive

Item	Model	SRK20ZJ-S				
		Indoor unit SRK20ZJ-S		Outdoor unit SRC20ZJ-S		
Cooling capacity (1)	W	2000 (1000 (Min.) ~ 2700 (Max.))				
Heating capacity (1)	W	2700 (1200 (Min.) ~ 3900 (Max.))				
Power supply		1 Phase, 220 ~ 240 V, 50Hz				
Operation data (1)	Power consumption	Cooling	kW	0.44 (0.21 ~ 0.77)		
		Heating		0.62 (0.27 ~ 1.38)		
	Running current	Cooling	A	2.5 / 2.4 / 2.3 (220/ 230/ 240 V)		
		Heating		3.2 / 3.1 / 3.0 (220/ 230/ 240 V)		
	Inrush current			3.2 / 3.1 / 3.0 (220/ 230/ 240 V)		
	COP	Cooling		4.55		
		Heating		4.35		
	Noise level	Cooling	Sound level	dB (A)	Hi: 33 Me: 27 Lo: 21	47
			Power level		49	59
		Heating	Sound level	dB (A)	Hi: 36 Me: 31 Lo: 24	46
Power level			52		58	
Exterior dimensions (Height x Width x Depth)	mm	294x798x229		540x780(+62)x290		
Exterior appearance (Munsell color)		Fine snow (8.0Y 9.3/0.1) near equivalent		Stucco white (4.2Y 7.5/1.1) near equivalent		
Net weight	kg	9.5		32		
Refrigerant equipment	Compressor type & Q'ty			—		
	Motor (Starting method)		kW	—		
	Refrigerant oil		ℓ	0.35 (DIAMOND FREEZE MA68)		
	Refrigerant (3)		kg	R410A 0.75 (Pre-Charged up to the piping length of 15m)		
	Heat exchanger			Louver fins & inner grooved tubing	M fins & inner grooved tubing	
	Refrigerant control			Capillary tubes + Electronic expansion valve		
Air handling equipment	Deice control			Microcomputer control		
	Fan type & Q'ty			Tangential fan x 1	Propeller fan x 1	
	Motor		W	38		24
	Air flow	Cooling	CMM	Hi: 7.8 Me: 5.6 Lo: 4.8		29.5
		Heating		Hi: 9.8 Me: 6.3 Lo: 5.0		25.6
	Fresh air intake			Not possible		—
Air filter, Quality / Quantity			Polypropylene net (washable) x 2		—	
Shock & vibration absorber			—		Cushion rubber (for compressor)	
Electric heater			—		—	
Operation control	Operation switch			Wireless-Remote control		
	Room temperature control			Microcomputer thermostat		
	Operation Display			RUN: Green, TIMER: Yellow, HI POWER: Green, 3D AUTO: Green		
Safety devices			Compressor overheat protection, Overcurrent protection, Frost protection, Serial signal error protection, Indoor fan motor error protection, Heating overload protection(High pressure control), Cooling overload protection			
Installation data	Refrigerant piping size (O.D)		mm	Liquid line: ϕ 6.35 (1/4") Gas line: ϕ 9.52 (3/8")		
	connecting method			Flare connecting		
	Attached length of piping		m	Liquid line : 0.53	—	
	Insulation for piping			Necessary (Both sides), independent		
	Refrigerant line (one way)length			Max.15		
Vertical height difference between outdoor unit and indoor unit		m	Max.10 (Outdoor unit is higher)			
			Max.10 (Outdoor unit is lower)			
Drain hose			Connectable (VP 16)		—	
Power cable			—			
Recommended breaker size	A		16			
Connection wiring	Size x Core numbe		1.5mm ² x 4 cores (Including earth cable)			
	Connecting method		Terminal block (Screw fixing type)			
Accessories (included)			Mounting kit, Clean filter (Allergen clear filter x 1, Photocatalytic washable deodorizing filter x 1)			
Optional parts			Interface kit (SC-BIKN-E)			
Note (1) The data are measured at the following conditions.				The pipe length is 7.5m.		
Operation	Item	Indoor air temperature		Outdoor air temperature		Standards
		DB	WB	DB	WB	
	Cooling	27°C	19°C	35°C	24°C	
Heating	20°C	—	7°C	6°C		
(2) This air-conditioner is manufactured and tested in conformity with the ISO.						
(3) The operation data are applied to the 220/230/240V districts respectively.						
(4) The refrigerant quantity to be charged includes the refrigerant in 15m connecting piping. (Purging is not required even for the short piping.)						

RWA000Z225A

Adapted to RoHS directive

Item			Model	SRK25ZJ-S		
				Indoor unit	SRK25ZJ-S	Outdoor unit
Cooling capacity (1)			W	2500 (1000 (Min.) ~ 2900 (Max.))		
Heating capacity (1)			W	3200 (1200 (Min.) ~ 4200 (Max.))		
Power supply				1 Phase, 220 ~ 240 V, 50Hz		
Operation data (1)	Power consumption	Cooling	kW	0.62 (0.21 ~ 0.88)		
		Heating		0.80 (0.27 ~ 1.36)		
	Running current	Cooling	A	3.2 / 3.1 / 3.0 (220/ 230/ 240 V)		
		Heating		4.0 / 3.8 / 3.7 (220/ 230/ 240 V)		
	Inrush current			4.0 / 3.8 / 3.7 (220/ 230/ 240 V)		
	COP	Cooling		4.03		
		Heating		4.00		
	Noise level	Cooling	Sound level	dB (A)	Hi: 34 Me: 28 Lo: 21	
			Power level		50	
Heating		Sound level	dB (A)	Hi: 39 Me: 31 Lo: 24		
		Power level		55		
Exterior dimensions (Height x Width x Depth)			mm	294x798x229	540x780(+62)x290	
Exterior appearance (Munsell color)				Fine snow (8.0Y 9.3/0.1) near equivalent	Stucco white (4.2Y 7.5/1.1) near equivalent	
Net weight			kg	9.5	32	
Refrigerant equipment	Compressor type & Q'ty			—	RM-B5077MDE1 (Rotary type) x 1	
	Motor (Starting method)		kW	—	0.75 (Line starting)	
	Refrigerant oil		ℓ	0.35 (DIAMOND FREEZE MA68)		
	Refrigerant (3)		kg	R410A 0.75 (Pre-Charged up to the piping length of 15m)		
	Heat exchanger			Louver fins & inner grooved tubing	M fins & inner grooved tubing	
	Refrigerant control			Capillary tubes + Electronic expansion valve		
Deice control			Microcomputer control			
Air handling equipment	Fan type & Q'ty			Tangential fan x 1	Propeller fan x 1	
	Motor		W	38	24	
	Air flow	Colling	CMM	Hi: 7.9 Me: 6.0 Lo: 5.0		
		Heating		Hi: 10.6 Me: 6.5 Lo: 5.1		
	Fresh air intake			Not possible		
Air filter, Quality / Quantity			Polypropylene net (washable) x 2			
Shock & vibration absorber				—	Cushion rubber (for compressor)	
Electric heater				—	—	
Operation control	Operation switch			Wireless-Remote control	—	
	Room temperature control			Microcomputer thermostat	—	
	Operation Display			RUN: Green, TIMER: Yellow, HI POWER: Green, 3D AUTO: Green		
Safety devices				Compressor overheat protection, Overcurrent protection, Frost protection, Serial signal error protection, Indoor fan motor error protection, Heating overload protection(High pressure control), Cooling overload protection		
Installation data	Refrigerant piping size (O.D)		mm	Liquid line: ϕ 6.35 (1/4") Gas line: ϕ 9.52 (3/8")		
	connecting method			Flare connecting		
	Attached length of piping		m	Liquid line : 0.53 Gas Line : 0.40	—	
	Insulation for piping			Necessary (Both sides), independent		
	Refrigerant line (one way)length			Max.15		
Vertical height difference between outdoor unit and indoor unit		m	Max.10 (Outdoor unit is higher) Max.10 (Outdoor unit is lower)			
Drain hose				Connectable (VP 16)	—	
Power cable				—	—	
Recommended breaker size			A	16		
Connection wiring	Size x Core numbe			1.5mm ² x 4 cores (Including earth cable)		
	Connecting method			Terminal block (Screw fixing type)		
Accessories (included)				Mounting kit, Clean filter (Allergen clear filter x 1, Photocatalytic washable deodorizing filter x 1)		
Optional parts				Interface kit (SC-BIKN-E)		
Note (1) The data are measured at the following conditions.				The pipe length is 7.5m.		
Operation	Cooling	Indoor air temperature		Outdoor air temperature		Standards
		DB	WB	DB	WB	
	27°C	19°C	35°C	24°C		
Heating		20°C	—	7°C	6°C	ISO-T1 , JIS C 9612
(2) This air-conditioner is manufactured and tested in conformity with the ISO.						
(3) The operation data are applied to the 220/230/240V districts respectively.						
(4) The refrigerant quantity to be charged includes the refrigerant in 15m connecting piping. (Purging is not required even for the short piping.)						

RWA000Z225 

Adapted to RoHS directive

Item			Model	SRK35ZJ-S		
				Indoor unit SRK35ZJ-S	Outdoor unit SRC35ZJ-S	
Cooling capacity (1)			W	3500 (1000 (Min.) ~ 3800 (Max.))		
Heating capacity (1)			W	4000 (1300 (Min.) ~ 4800 (Max.))		
Power supply				1 Phase, 220 ~ 240 V, 50Hz		
Operation data (1)	Power consumption	Cooling	kW	1.01 (0.21 ~ 1.24)		
		Heating		1.00 (0.29 ~ 1.45)		
	Running current	Cooling	A	4.9 / 4.7 / 4.5 (220/ 230/ 240 V)		
		Heating		4.9 / 4.7 / 4.5 (220/ 230/ 240 V)		
	Inrush current			4.9 / 4.7 / 4.5 (220/ 230/ 240 V)		
	COP	Cooling		3.47		
		Heating		4.00		
	Noise level	Cooling	Sound level	dB (A)	Hi: 42 Me: 32 Lo: 22	50
			Power level	dB	58	62
		Heating	Sound level	dB (A)	Hi: 43 Me: 37 Lo: 25	51
Power level			dB	59	63	
Exterior dimensions (Height x Width x Depth)			mm	294x798x229	540x780(+62)x290	
Exterior appearance (Munsell color)				Fine snow (8.0Y 9.3/0.1) near equivalent	Stucco white (4.2Y 7.5/1.1) near equivalent	
Net weight			kg	9.5	35	
Refrigerant equipment	Compressor type & Q'ty			—	RM-B5077MDE1 (Rotary type) x 1	
	Motor (Starting method)		kW	—	0.90 (Line starting)	
	Refrigerant oil		ℓ	0.35 (DIAMOND FREEZE MA68)		
	Refrigerant (3)		kg	R410A 1.05 (Pre-Charged up to the piping length of 15m)		
	Heat exchanger			Louver fins & inner grooved tubing	M fins & inner grooved tubing	
	Refrigerant control			Capillary tubes + Electronic expansion valve		
Deice control			Microcomputer control			
Air handling equipment	Fan type & Q'ty			Tangential fan x 1	Propeller fan x 1	
	Motor		W	38	24	
	Air flow	Colling	CMM	Hi: 10.1 Me: 6.4 Lo: 5.0		
		Heating		Hi: 12.8 Me: 9.4 Lo: 6.1		
	Fresh air intake			Not possible		
Air filter, Quality / Quantity			Polypropylene net (washable) x 2			
Shock & vibration absorber				—	Cushion rubber (for compressor)	
Electric heater				—	—	
Operation control	Operation switch			Wireless-Remote control		
	Room temperature control			Microcomputer thermostat		
	Operation Display			RUN: Green, TIMER: Yellow, HI POWER: Green, 3D AUTO: Green		
Safety devices				Compressor overheat protection, Overcurrent protection, Frost protection, Serial signal error protection, Indoor fan motor error protection, Heating overload protection(High pressure control), Cooling overload protection		
Installation data	Refrigerant piping size (O.D)		mm	Liquid line: φ6.35 (1/4") Gas line: φ9.52 (3/8")		
	connecting method			Flare connecting		
	Attached length of piping		m	Liquid line : 0.53	—	
	Insulation for piping			Necessary (Both sides), independent		
	Refrigerant line (one way)length			Max.15		
Vertical height difference between outdoor unit and indoor unit		m	Max.10 (Outdoor unit is higher) Max.10 (Outdoor unit is lower)			
Drain hose				Connectable (VP 16)	—	
Power cable				—	—	
Recommended breaker size			A	16		
Connection wiring	Size x Core numbe			1.5mm ² x 4 cores (Including earth cable)		
	Connecting method			Terminal block (Screw fixing type)		
Accessories (included)				Mounting kit, Clean filter (Allergen clear filter x 1, Photocatalytic washable deodorizing filter x 1)		
Optional parts				Interface kit (SC-BIKN-E)		
Note (1) The data are measured at the following conditions.				The pipe length is 7.5m.		
Operation	Item	Indoor air temperature		Outdoor air temperature		Standards
		DB	WB	DB	WB	
	Cooling	27°C	19°C	35°C	24°C	
Heating	20°C	—	7°C	6°C		
(2) This air-conditioner is manufactured and tested in conformity with the ISO.						
(3) The operation data are applied to the 220/230/240V districts respectively.						
(4) The refrigerant quantity to be charged includes the refrigerant in 15m connecting piping. (Purging is not required even for the short piping.)						

RWA000Z225 

2 EXTERIOR DIMENSIONS

(1) Indoor units

Models SRK20ZJ-S, 25ZJ-S, 35ZJ-S

Symbol	Content	
A	Gas piping	φ9.52(3/8") (Flare)
B	Liquid piping	φ6.35(1/4") (Flare)
C	Hole on wall for right rear piping	(φ65)
D	Hole on wall for left rear piping	(φ65)
E	Drain hose	VP16
F	Outlet for wiring	
G	Outlet for piping (on both side)	

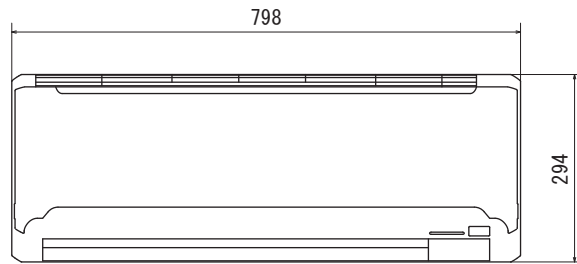
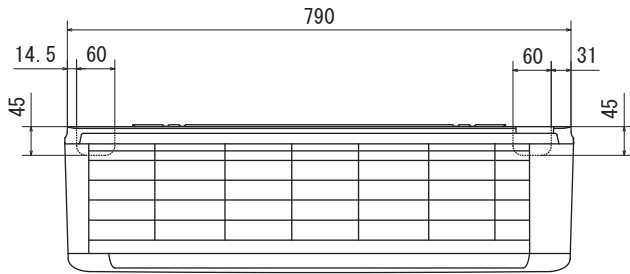

Outlet for down piping
(Refer to the above view)

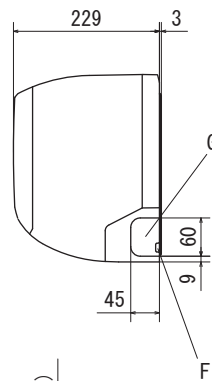

Wireless remote controller

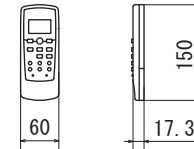

Wired - remote controller
(Option)

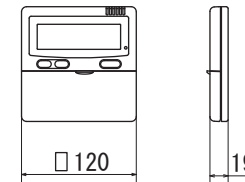

- Notes (1) The model name label is attached on the underside of the panel.
(2) It takes the interface kit (SC-BIKN-E) to connect the wired remote controller.

Unit:mm

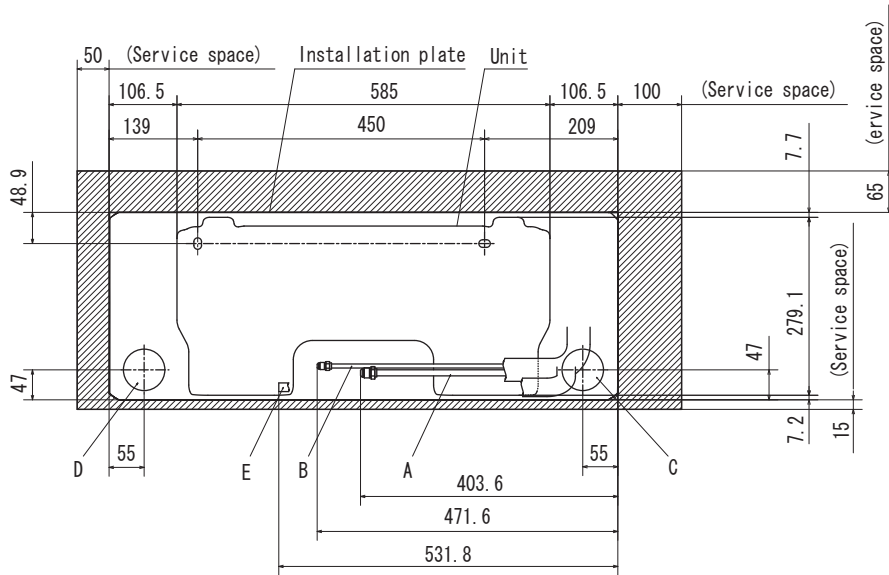

Space for installation and service when viewing from the front

RLA000Z051

RCV000Z006 A

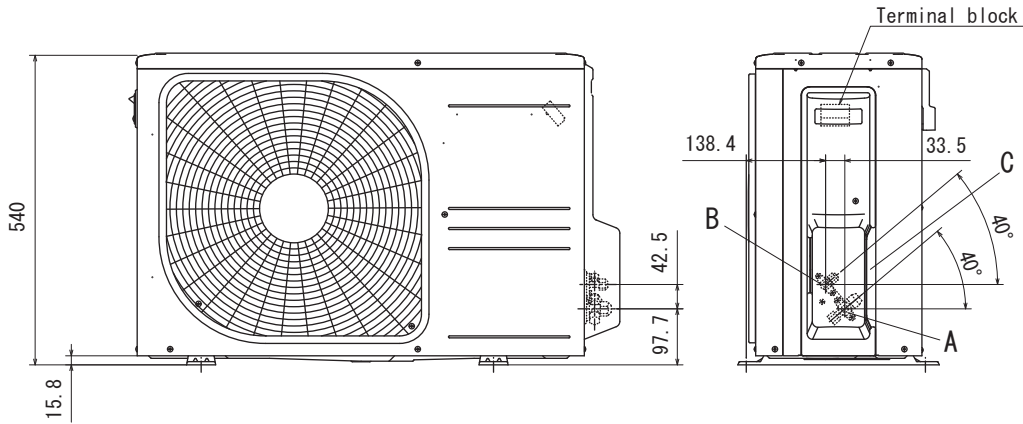
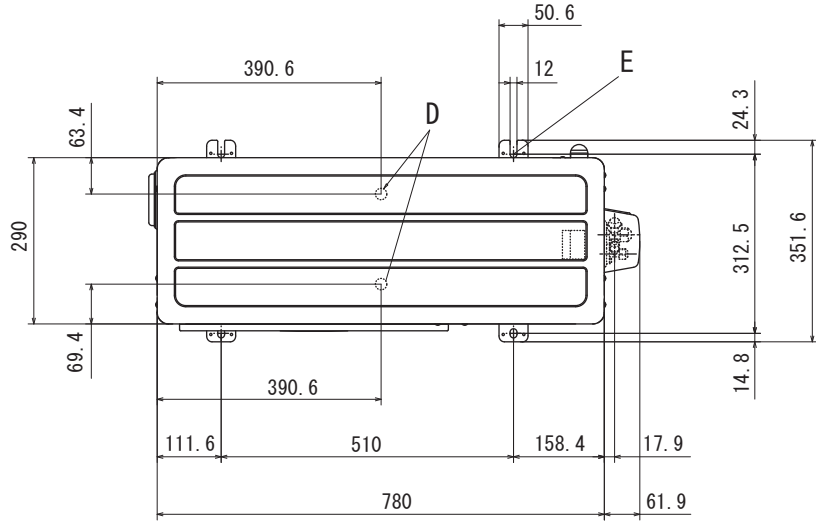

Notes

- (1) It must not be surrounded by walls on the four sides.
- (2) The unit must be fixed with anchor bolts. An anchor bolt must not protrude more than 15mm.
- (3) Where the unit is subject to strong winds, lay it in such a direction that the blower outlet faces perpendicularly to the dominant wind direction.
- (4) Leave 1m or more space above the unit.
- (5) A wall in front of the blower outlet must not exceed the units height.
- (6) The model name label is attached on the lower right corner of the front panel.

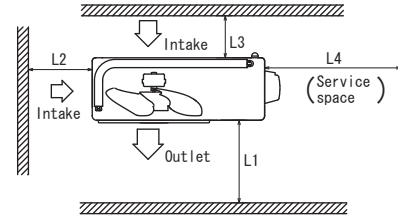

Minimum installation space

Examples of installation Dimensions	I	II	III	IV
L1	Open	280	280	180
L2	100	75	Open	Open
L3	100	80	80	80
L4	250	Open	250	Open

Symbol	Content	
A	Service valve connection (gas side)	φ9.52 (3/8") (Flare)
B	Service valve connection (liquid side)	φ6.35 (1/4") (Flare)
C	Pipe/cable draw-out hole	
D	Drain discharge hole	φ20x2places
E	Anchor bolt hole	M10x4places

Unit:mm

(2) Outdoor units
Models SRC20ZJ-S, 25ZJ-S, 35ZJ-S

3 ELECTRICAL WIRING

(1) Indoor units

Models SRK20ZJ-S, 25ZJ-S, 35ZJ-S

Item	Description
CNE-CNY	Connector
FM _i	Fan motor
SM _i	Flap motor
LM _{1,2}	Louver motor
HD	Humidity sensor
Th ₁	Room temp. sensor
Th _{2,3}	Heat exch. sensor
DS	Diode stack
F	Fuse
T	Terminal block
Va	Varistor

Mark	Color
BK	Black
BL	Blue
RD	Red
WH	White
Y	Yellow
Y/G	Yellow/Green

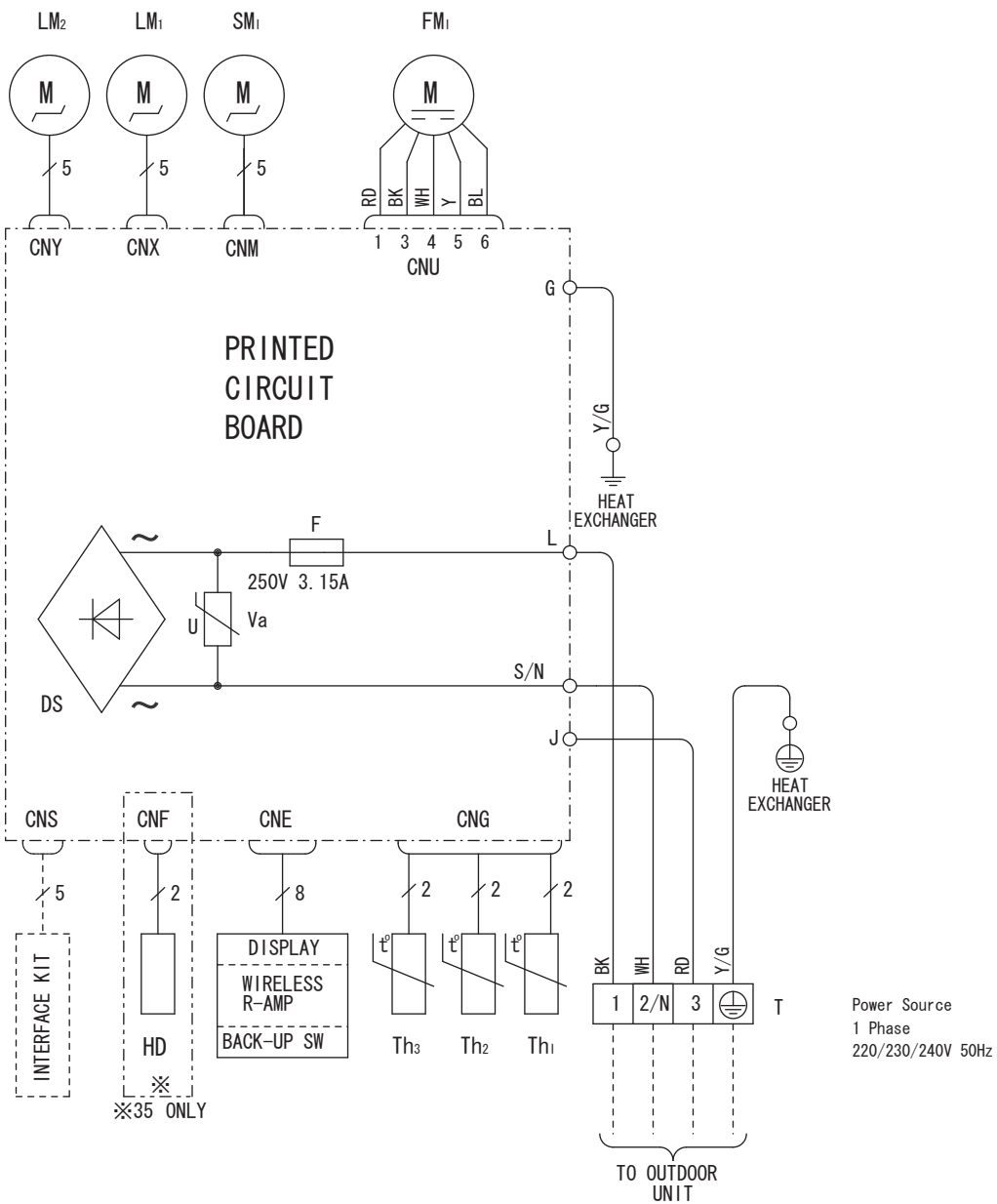

Power Source
1 Phase
220/230/240V 50Hz

RWA000Z226

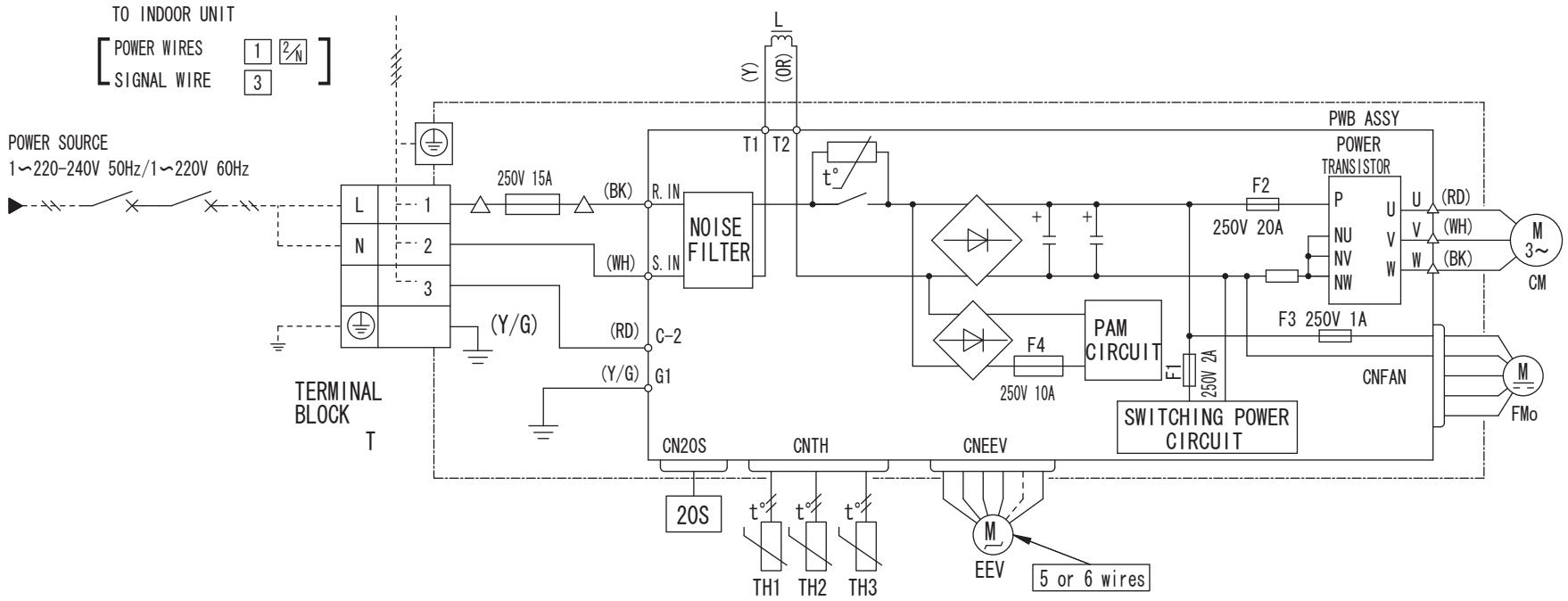

Power cable, indoor-outdoor connecting wires

Model	MAX running current (A)	Power cable size (mm ²)	Power cable length (m)	indoor-outdoor wire size x number	Earth wire size (mm)
20					
25	8	2.0	32	φ1.6mm x 3	φ1.6mm
35					

- The specifications shown in the above table are for units without heaters. For units with heaters, refer to the installation instructions or the construction instructions of the indoor unit.
- Switchgear of Circuit breaker capacity which is calculated from MAX. over current should be chosen along the regulations in each country.
- The cable specifications are based on the assumption that a metal or plastic conduit is used with no more than three cables contained in a conduit and a voltage drop is 2%. For an installation falling outside of these conditions, please follow the internal cabling regulations. Adapt it to the regulation in effect in each country.

Item	Description
CM	Compressor motor
CNEEV~20S	Connector
EEV	Electric expansion valve (coil)
FMo	Fan motor
L	Reactor
T	Terminal block
TH1	Heat exchanger sensor (ioutdoor unit)
TH2	Outdoor air temp. sensor
TH3	Discharge pipe temp. sensor
20S	Solenoid valve for 4 way valve

Mark	Color
BK	Black
OR	Orange
RD	Red
WH	White
Y	Yellow
Y/G	Yellow/Green

(2) Outdoor units
 Models SRC20ZJ-S, 25ZJ-S, 35ZJ-S

RWC000Z213A

4 NOISE LEVEL

Model SRK20ZJ-S

Condition ISO-T1, JIS C9612

(Indoor Unit)

Model	SRK20ZJ-S	
Noise Level	Cooling	33 dB(A)
	Heating	36 dB(A)

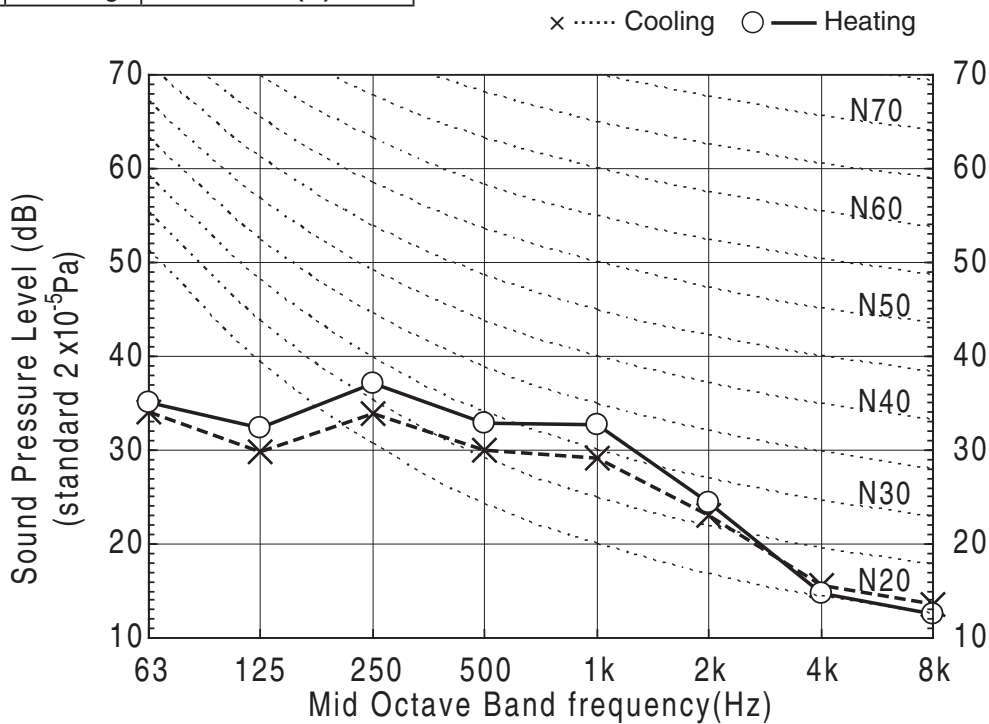

(Outdoor Unit)

Model	SRC20ZJ-S	
Noise Level	Cooling	47 dB(A)
	Heating	46 dB(A)

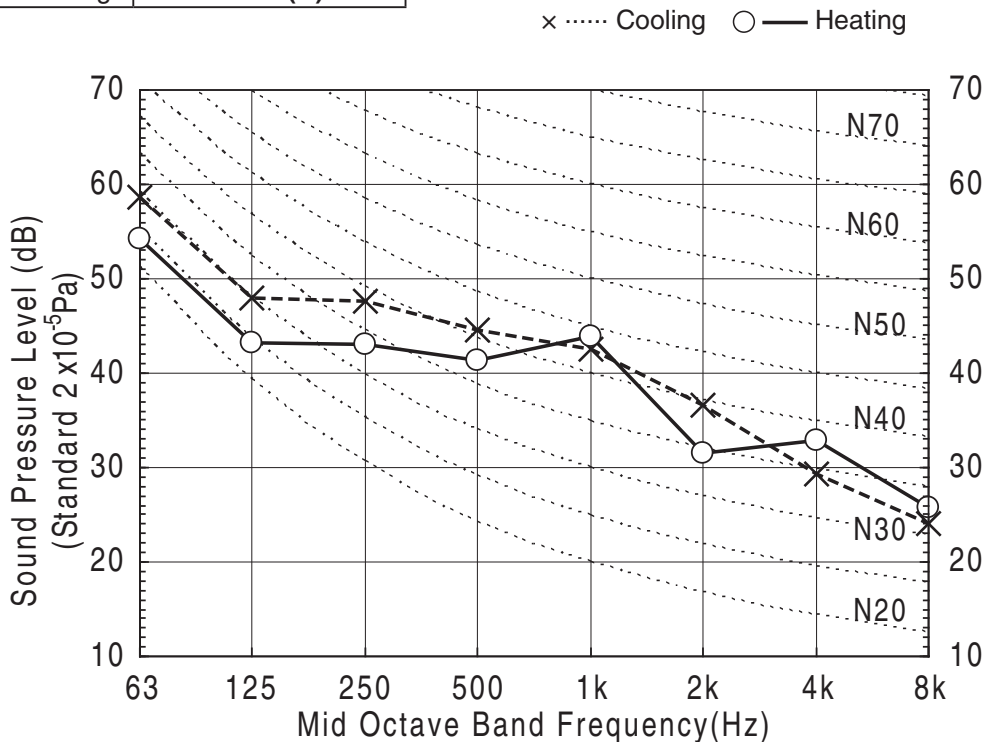

Model SRK25ZJ-S

Condition ISO-T1, JIS C9612

(Indoor Unit)

Model	SRK25ZJ-S	
Noise Level	Cooling	34 dB(A)
	Heating	39 dB(A)

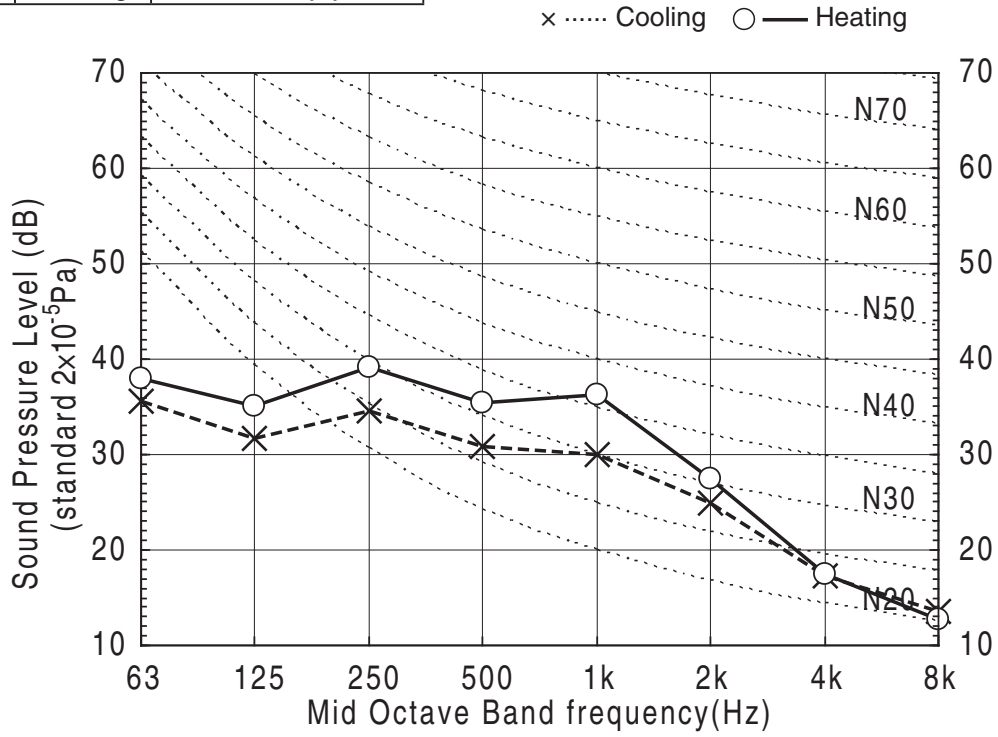

(Outdoor Unit)

Model	SRC25ZJ-S	
Noise Level	Cooling	48 dB(A)
	Heating	49 dB(A)

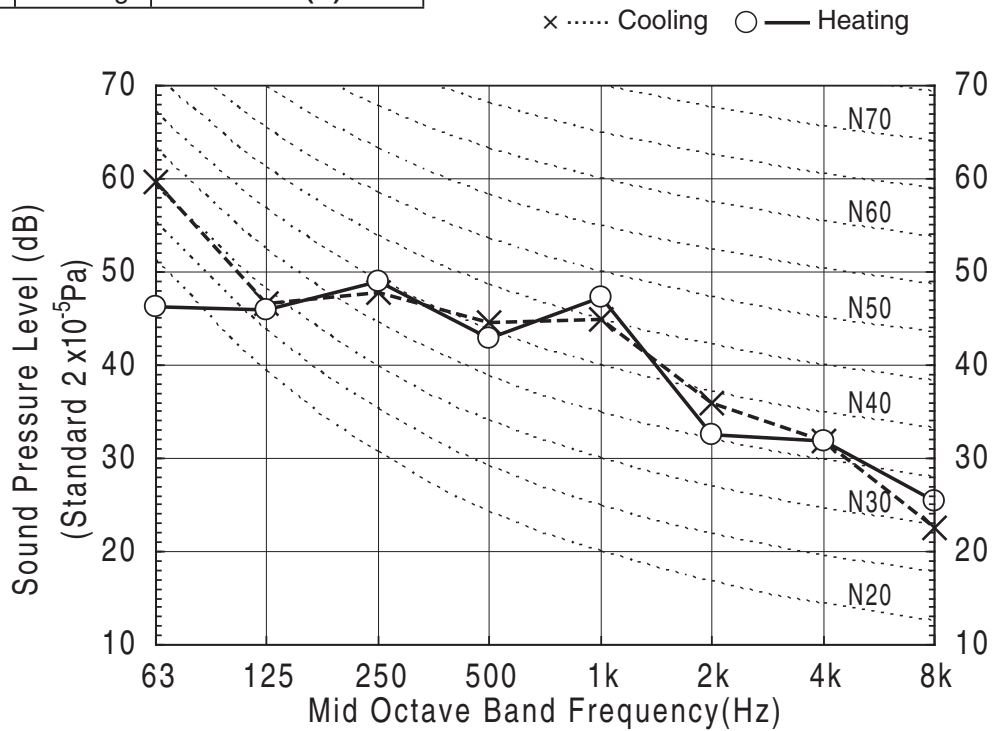

Model SRK35ZJ-S

Condition ISO-T1, JIS C9612

(Indoor Unit)

Model	SRK35ZJ-S	
Noise Level	Cooling	42 dB(A)
	Heating	43 dB(A)

× Cooling ○ — Heating

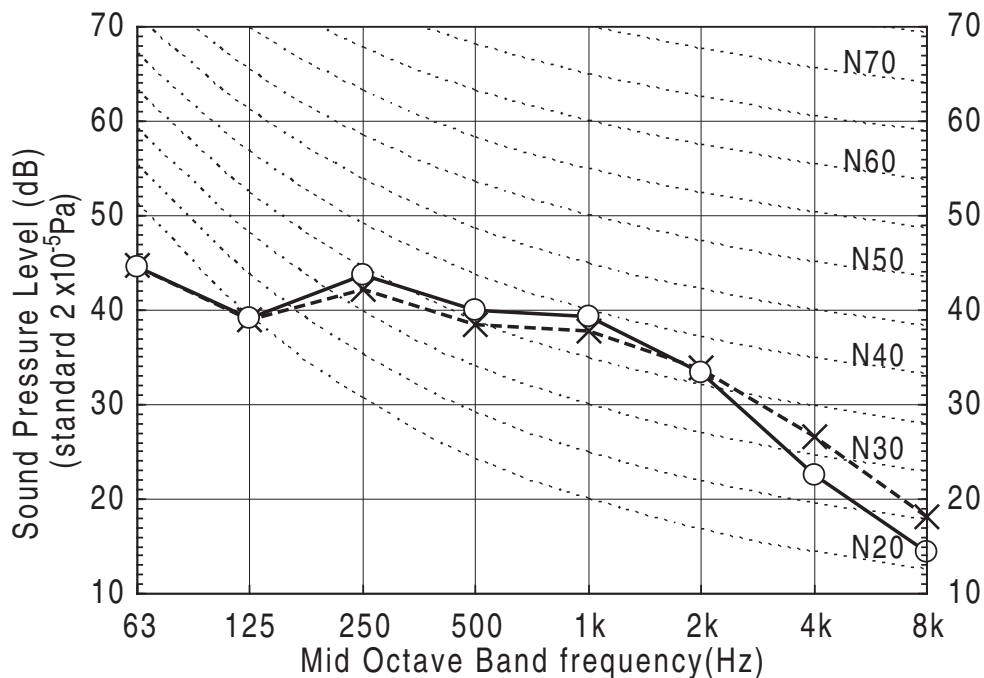

(Outdoor Unit)

Model	SRC35ZJ-S	
Noise Level	Cooling	50 dB(A)
	Heating	51 dB(A)

× Cooling ○ — Heating

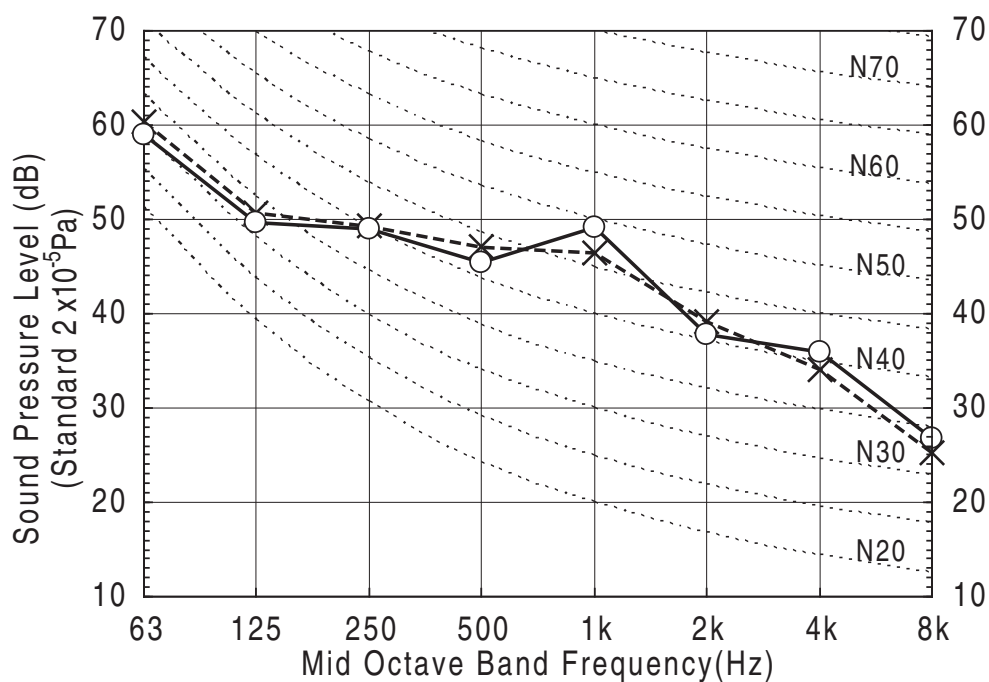

5 PIPING SYSTEM

Models SRK20ZJ-S, 25ZJ-S

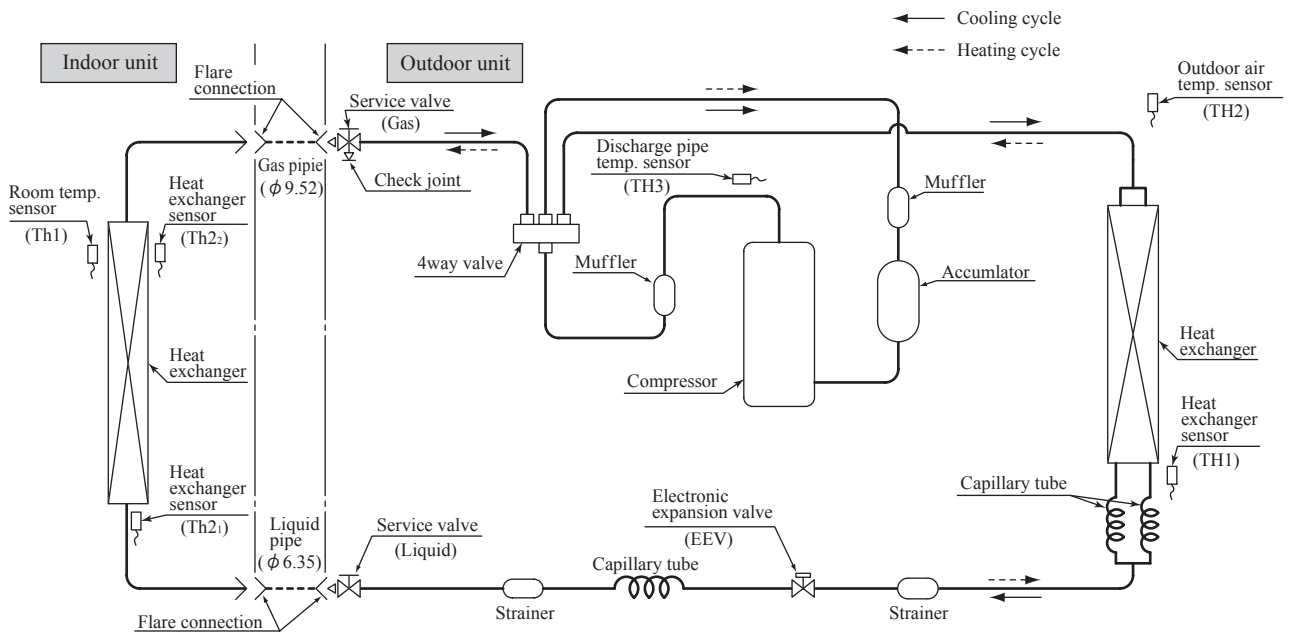

Model SRK35ZJ-S

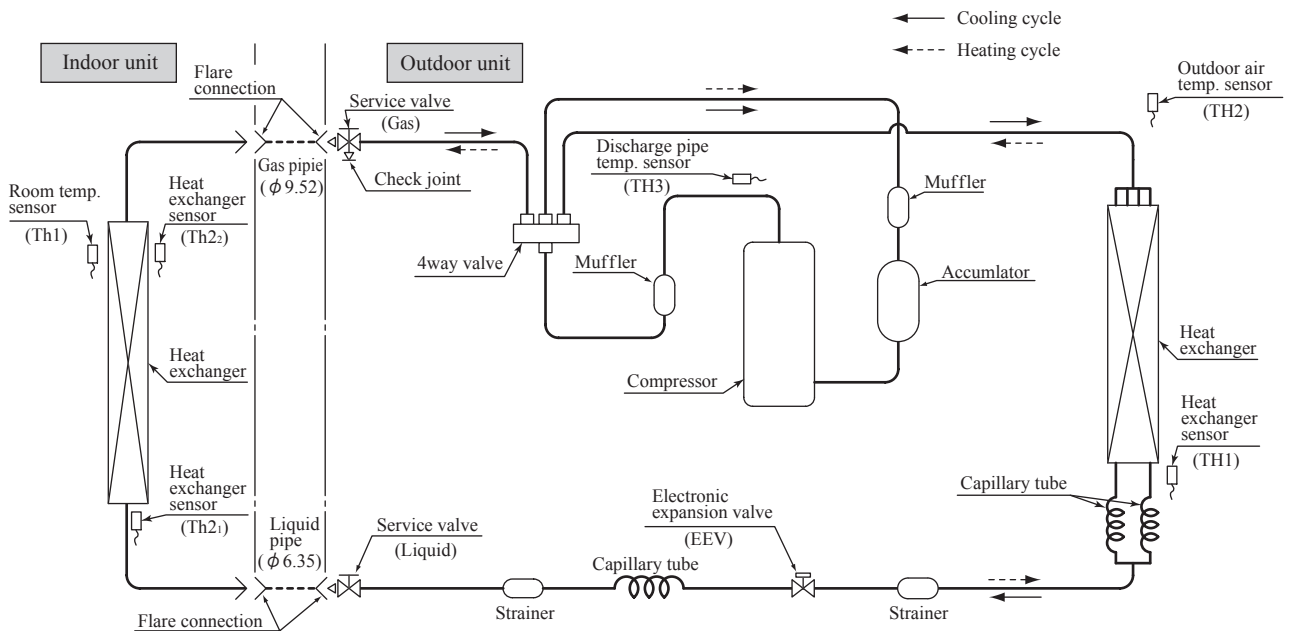

6 APPLICATION DATA

(1) Installation of indoor unit



- This instruction manual illustrates the method of installing an indoor unit.
- For outdoor unit installation and refrigerant piping, please refer to page 17.
- A wired remote control unit is supplied separately as an optional part.

- When install the unit, be sure to check whether the selection of installation place, power supply specifications, usage limitation (piping length, height differences between indoor and outdoor units, power supply voltage and etc.) and installation spaces.

SAFETY PRECAUTIONS

- We recommend you to read this "SAFETY PRECAUTIONS" carefully before the installation work in order to gain full advantage of the functions of the unit and to avoid malfunction due to mishandling.
- The precautions described below are divided into **⚠ WARNING** and **⚠ CAUTION**. The matters with possibilities leading to serious consequences such as death or serious personal injury due to erroneous handling are listed in the **⚠ WARNING** and the matters with possibilities leading to personal injury or damage of the unit due to erroneous handling including probability leading to serious consequences in some cases are listed in **⚠ CAUTION**. These are very important precautions for safety. Be sure to observe all of them without fail.
- Be sure to confirm no anomaly on the equipment by commissioning after completed installation and explain the operating methods as well as the maintenance methods of this equipment to the user according to the owner's manual.

- Keep the installation manual together with owner's manual at a place where any user can read at any time. Moreover if necessary, ask to hand them to a new user.
- For installing qualified personnel, take precautions in respect to themselves by using suitable protective clothing, gloves, etc., and then perform the installation works.
- Please pay attention not to fall down the tools, etc. when installing the unit at the high position.
- If unusual noise can be heard during operation, consult the dealer.
- Symbols which appear frequently in the text have the following meaning:

 Observe instructions with great care	 Strictly prohibited	 Provide proper earthing
--	---	--

RLA012A012

⚠ WARNING

- **Do not vent R410A into the atmosphere : R410A is a fluorinated greenhouse gas, covered by the Kyoto Protocol with Global Warming Potential (GWP)=1975.**
- **Do not run the unit with removed panels or protections.**
Touching rotating equipments, hot surfaces or high voltage parts can cause personal injury due to entrapment, burn or electric shocks.
- **Do not perform any change of protective device itself or its setup condition.**
The forced operation by short-circuiting protective device of pressure switch and temperature controller or the use of non specified component can cause fire or burst.
- **Carry out the electrical work for ground lead with care.**
Do not connect the ground lead to the gas line, water line, lightning conductor or telephone line's ground lead. Incorrect grounding can cause unit faults such as electric shocks due to short-circuiting.

⚠ CAUTION

- **Use the circuit breaker with sufficient breaking capacity.**
If the breaker does not have sufficient breaking capacity, it can cause the unit malfunction and fire.
- **Earth leakage breaker must be installed.**
If the earth leakage breaker is not installed, it can cause electric shocks.
- **Install isolator or disconnect switch on the power supply wiring in accordance with the local codes and regulations.**
- **Be sure to install indoor unit properly according to the instruction manual in order to run off the drainage smoothly.**
Improper installation of indoor unit can cause dropping water into the room and damaging personal property.
- **Install the drainage pipe to run off drainage securely according to the installation manual.**
Incorrect installation of the drainage pipe can cause dropping water into the room and damaging personal property.
- **Be sure to install the drainage pipe with descending slope of 1/100 or more, and not to make traps and air-bleedings.**
Check if the drainage runs off securely during commissioning and ensure the space for inspection and maintenance.
- **Secure a space for installation, inspection and maintenance specified in the manual.**
Insufficient space can result in accident such as personal injury due to falling from the installation place.
- **For installation work, be careful not to get injured with the heat exchanger, piping flare portion or screws etc.**
- **Be sure to insulate the refrigerant pipes so as not to condense the ambient air moisture on them.**
Insufficient insulation can cause condensation, which can lead to moisture damage on the ceiling, floor, furniture and any other valuables.
- **When perform the air conditioner operation (cooling or drying operation) in which ventilator is installed in the room. In this case, using the air conditioner in parallel with the ventilator, there is the possibility that drain water may backflow in accordance with the room lapse into the negative pressure status. Therefore, set up the opening port such as incorporate the air into the room that may appropriate to ventilation (For example: Open the door a little). In addition, just as above, so set up the opening port if the room lapse into negative pressure status due to register of the wind for the high rise apartment etc.**

⚠ WARNING

- **Installation must be carried out by the qualified installer.**
If you install the system by yourself, it may cause serious trouble such as water leaks, electric shocks, fire and personal injury, as a result of a system malfunction.
- **Install the system in full accordance with the instruction manual.**
Incorrect installation may cause bursts, personal injury, water leaks, electric shocks and fire.
- **Be sure to use only for household and residence.**
If this appliance is installed in inferior environment such as machine shop and etc., it can cause malfunction.
- **Use the original accessories and the specified components for installation.**
If parts other than those prescribed by us are used, it may cause water leaks, electric shocks, fire and personal injury.
- **Install the unit in a location with good support.**
Unsuitable installation locations can cause the unit to fall and cause material damage and personal injury.
- **Ventilate the working area well in the event of refrigerant leakage during installation.**
If the refrigerant comes into contact with naked flames, poisonous gas is produced.
- **When installing in small rooms, take prevention measures not to exceed the density limit of refrigerant in the event of leakage.**
Consult the expert about prevention measures. If the density of refrigerant exceeds the limit in the event of leakage, lack of oxygen can occur, which can cause serious accidents.
- **After completed installation, check that no refrigerant leaks from the system.**
If refrigerant leaks into the room and comes into contact with an oven or other hot surface, poisonous gas is produced.
- **Use the prescribed pipes, flare nuts and tools for R410A.**
Using existing parts (for R22 or R407C) can cause the unit failure and serious accidents due to burst of the refrigerant circuit.
- **Tighten the flare nut by torque wrench with specified method.**
If the flare nut were tightened with excess torque, this may cause burst and refrigerant leakage after a long period.
- **The electrical installation must be carried out by the qualified electrician in accordance with "the norm for electrical work" and "national wiring regulation", and the system must be connected to the dedicated circuit.**
Power supply with insufficient capacity and incorrect function done by improper work can cause electric shocks and fire.
- **Be sure to shut off the power before starting electrical work.**
Failure to shut off the power can cause electric shocks, unit failure or incorrect function of equipment.
- **Be sure to use the cables conformed to safety standard and cable ampacity for power distribution work.**
Unconformable cables can cause electric leak, anomalous heat production or fire.
- **This appliance must be connected to main power supply by means of a circuit breaker or switch (fuse:16A) with a contact separation of at least 3mm.**
- **When plugging this appliance, a plug conforming to the norm IEC60884-1 must be used.**
- **Use the prescribed cables for electrical connection, tighten the cables securely in terminal block and relieve the cables correctly to prevent overloading the terminal blocks.**
Loose connections or cable mountings can cause anomalous heat production or fire.
- **Arrange the wiring in the control box so that it cannot be pushed further into the box. Install the service panel correctly.**
Incorrect installation may result in overheating and fire.
- **Be sure to switch off the power supply in the event of installation, inspection or servicing.**
If the power supply is not shut off, there is a risk of electric shocks, unit failure or personal injury due to the unexpected start of fan.

- **Do not put the drainage pipe directly into drainage channels where poisonous gases such as sulphide gas can occur.**
Poisonous gases will flow into the room through drainage pipe and seriously affect the user's health and safety.
- **Ensure that no air enters in the refrigerant circuit when the unit is installed and removed.**
If air enters in the refrigerant circuit, the pressure in the refrigerant circuit becomes too high, which can cause burst and personal injury.
- **Do not processing, splice the power cord, or share a socket with other power plugs.**
This may cause fire or electric shock due to defecting contact, defecting insulation and over-current etc.
- **Do not bundling, winding or processing for the power cord. Or, do not deforming the power plug due to tread it.**
This may cause fire or heating.

- **Do not install the unit in the locations listed below.**
 - Locations where carbon fiber, metal powder or any powder is floating.
 - Locations where any substances that can affect the unit such as sulphide gas, chloride gas, acid and alkaline can occur.
 - Vehicles and ships.
 - Locations where cosmetic or special sprays are often used.
 - Locations with direct exposure of oil mist and steam such as kitchen and machine plant.
 - Locations where any machines which generate high frequency harmonics are used.
 - Locations with salty atmospheres such as coastlines.
 - Locations with heavy snow (If installed, be sure to provide base flame and snow hood mentioned in the manual).
 - Locations where the unit is exposed to chimney smoke.
 - Locations at high altitude (more than 1000m high).
 - Locations with ammoniac atmospheres.
 - Locations where heat radiation from other heat source can affect the unit.
 - Locations without good air circulation.
 - Locations with any obstacles which can prevent inlet and outlet air of the unit.
 - Locations where short circuit of air can occur (in case of multiple units installation).
 - Locations where strong air blows against the air outlet of outdoor unit. It can cause remarkable decrease in performance, corrosion and damage of components, malfunction and fire.
- **Do not install the indoor unit in the locations listed below (Be sure to install the indoor unit according to the installation manual for each model because each indoor unit has each limitation).**
 - Locations with any obstacles which can prevent inlet and outlet air of the unit.
 - Locations where vibration can be amplified due to insufficient strength of structure.
 - Locations where the infrared receiver is exposed to the direct sunlight or the strong light beam (in case of the infrared specification unit).
 - Locations where an equipment affected by high harmonics is placed (TV set or radio receiver is placed within 1m).
 - Locations where drainage cannot run off safely. It can affect performance or function and etc.
- **Do not install the unit near the location where leakage of combustible gases can occur.**
If leaked gases accumulate around the unit, it can cause fire.
- **Do not install the unit where corrosive gas (such as sulfurous acid gas etc.) or combustible gas (such as thinner and petroleum gases) can accumulate or collect, or where volatile combustible substances are handled.**
Corrosive gas can cause corrosion of heat exchanger, breakage of plastic parts and etc. And combustible gas can cause fire.
- **Do not use the indoor unit at the place where water splashes may occur such as in laundries.**
Since the indoor unit is not waterproof, it can cause electric shocks and fire.
- **Do not install nor use the system close to the equipment that generates electromagnetic fields or high frequency harmonics.**
Equipment such as inverters, standby generators, medical high frequency equipments and telecommunication equipments can affect the system, and cause malfunctions and breakdowns. The system can also affect medical equipment and telecommunication equipment, and obstruct its function or cause jamming.
- **Do not place any variables which will be damaged by getting wet under the indoor unit.**
When the relative humidity is higher than 80% or drainage pipe is clogged, condensation or drainage water can drop and it can cause the damage of valuables.
- **Do not install the remote control at the direct sunlight.**
It can cause malfunction or deformation of the remote control.
- **Do not use the unit for special purposes such as storing foods, cooling precision instruments and preservation of animals, plants or art.**
It can cause the damage of the items.
- **Do not use any materials other than a fuse with the correct rating in the location where fuses are to be used.**
Connecting the circuit with copper wire or other metal thread can cause unit failure and fire.
- **Do not touch any buttons with wet hands.**
It can cause electric shocks.
- **Do not touch any refrigerant pipes with your hands when the system is in operation.**
During operation the refrigerant pipes become extremely hot or extremely cold depending the operating condition, and it can cause burn injury or frost injury.

BEFORE INSTALLATION

○ Before installation check that the power supply matches the air conditioner.

Standard accessories (Installation kit)		Q'ty
Accessories for indoor unit		
①	Installation board (Attached to the rear of the indoor unit)	1
②	Wireless remote control	1
③	Remote control holder	1
④	Tapping screws (for installation board $\phi 4 \times 25\text{mm}$)	5
⑤	Wood screws (for remote control switch holder $\phi 3.5 \times 16\text{mm}$)	2
⑥	Battery [R03 (AAA, Micro) 1.5V]	2
⑦	Air-cleaning filters	2
⑧	Filter holders (Attached to the front panel of indoor unit)	2
⑨	Insulation (#486 50 x 100 t3)	1

Option parts		Q'ty
a	Sealing plate	
b	Sleeve	1
c	Inclination plate	1
d	Putty	1
e	Drain hose (extension hose)	1
f	Piping cover (for insulation of connection piping)	1

Necessary tools for the installation work	
1	Plus headed driver
2	Knife
3	Saw
4	Tape measure
5	Hammer
6	Spanner wrench
7	Torque wrench (14.0 - 61.0N·m (1.4 - 6.1kgf·m))
8	Hole core drill (65mm in diameter)
9	Wrench key (Hexagon) [4m/m]
10	Flaring tool set (Designed specifically for R410A)
11	Gas leak detector (Designed specifically for R410A)
12	Gauge for projection adjustment (Used when flare is made by using conventional flare tool)
13	Pipe bender

SELECTION OF INSTALLATION LOCATION

(Install at location that meets the following conditions, after getting approval from the customer)

Indoor unit

- Where there is no obstructions to the air flow and where the cooled and heated air can be evenly distributed.
- A solid place where the unit or the wall will not vibrate.
- A place where there will be enough space for servicing. (Where space mentioned below can be secured)
- Where wiring and the piping work will be easy to conduct.
- The place where receiving part is not exposed to the direct rays of the sun or the strong rays of the street lighting.
- A place where it can be easily drained.
- A place separated at least 1m away from the television or the radio. (To prevent interference to images and sounds.)
- Places where this unit is not affected by the high frequency equipment or electric equipment.
- Avoid installing this unit in place where there is much oil mist.
- Places where there is no electric equipment or household under the installing unit.

Wireless remote control

- A place where the air conditioner can be received the signal surely during operating the wireless remote control.
- Places where there is no affected by the TV and radio etc.
- Do not place where exposed to direct sunlight or near heat devices such as a stove.

INSTALLATION OF INDOOR UNIT

Installation of Installation board

Look for the inside wall structures (Intermediats support or pillar and firmly install the unit after level surface has been checked.)

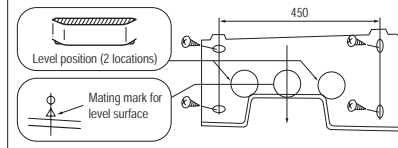

- Adjustment of the installation board in the horizontal direction is to be conducted with four screws in a temporary tightened state.
- Adjust so the board will be level by turning the board with the standard hole as the center.

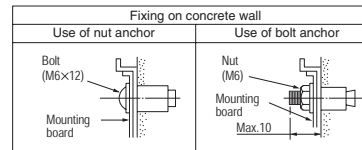

Drilling of holes and fixture of sleeve (Option parts)

When drilling the wall that contains a metal lath, wire lath or metal plate, be sure to use pipe hole sleeve sold separately.

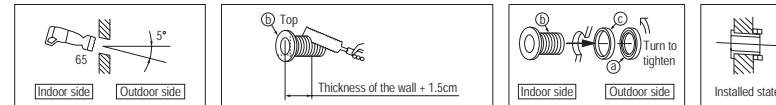

- Drill a hole with whole core drill.
- In case of rear piping draw out, cut off the lower and the right side portions of the sleeve collar.

Installing the support of piping

In case of piping in the right rear direction

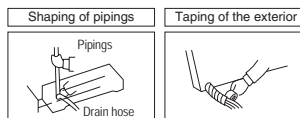

- Hold the bottom of the piping and fix direction before stretching it and shaping it.
- Tape only the portion that goes through the wall.
- Always tape the wiring with the piping.

Sufficient care must be taken not to damage the panel when connecting pipes.

Matters of special notice when piping from left or central/rear of the unit.

[Top view]

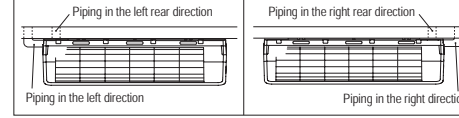

Piping is possible in the rear, left, left rear, left downward, right or downward direction.

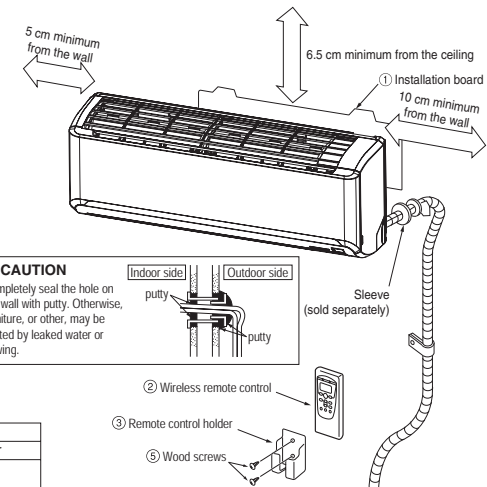
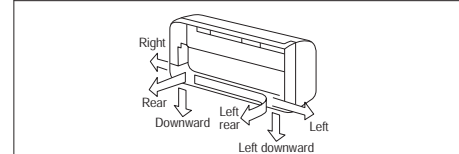

CAUTION

Completely seal the hole on the wall with putty. Otherwise, furniture, or other, may be wetted by leaked water or dewing.

Relation between setting plate and indoor unit

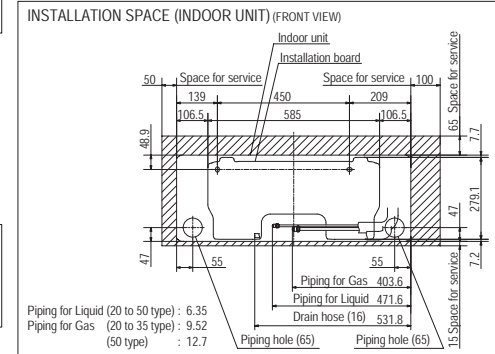

[Drain hose changing procedures]

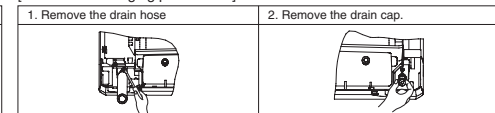

- Remove the screw and drain hose, making it rotate.
- Remove it with hand or pliers.

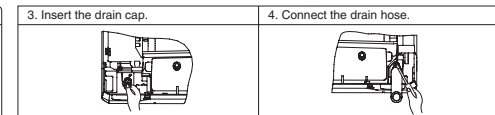

- Insert the drain cap which was removed at procedure "2" securely using a hexagonal wrench etc. Note: Be careful that if it is not inserted securely, water leakage may occur.
- Insert the drain hose securely, making rotate. And install the screw. Note: Be careful that if it is not inserted securely, water leakage may occur.

Fixing of indoor unit

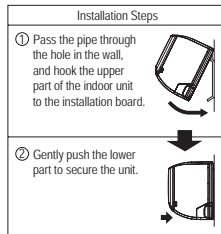
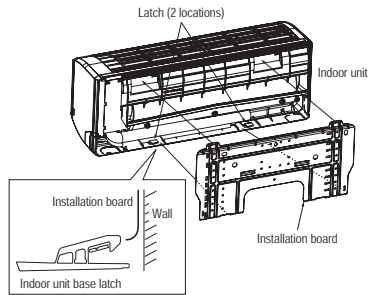

How to remove the indoor unit from the installation board

- Push up at the marked portion of the indoor unit base lower latch, and slightly pull it toward you. (both right and left hand sides) (The indoor unit base lower latch can be removed from the installation board)
- Push up the indoor unit upward. So the indoor unit will be removed from the installation board.

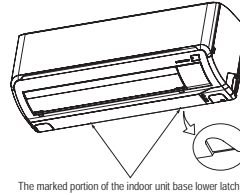

Since this air conditioner has been designed to collect dew drops on the rear surface to the drain pan, do not attach the power cord above the gutter.

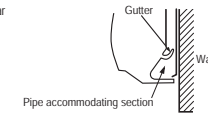

Drainage

- Arrange the drain hose in a downward angle.
 - Avoid the following drain piping.
- CAUTION** Go through all installation steps and check if the drainage is all right. Otherwise water leak may occur.

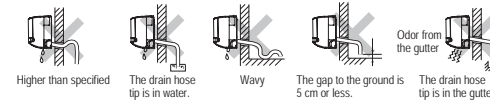

- Pour water to the drain pan located under the heat exchanger, and ensure that the water is discharged outdoor.
- When the extended drain hose is indoor, always use a shield pipe (to be arranged by the user) and ensure it is thermally insulated.

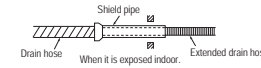

CONNECTION OF REFRIGERANT PIPINGS

Preparation Keep the openings of the pipes covered with tapes etc. to prevent dust, sand, etc. from entering them.

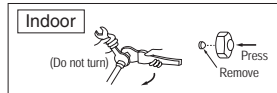

- Remove the flared nuts. (on both liquid and gas sides)

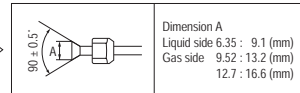

- Install the removed flared nuts to the pipes to be connected, then flared the pipes.

CAUTION
Do not apply refrigerating machine oil to the flared surface.

Flaring work

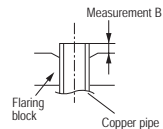

Copper pipe diameter	Measurement B (mm)		
	Clutch type flare tool for R410A	Conventional (R22) flare tool	
		Clutch type	Wing nut type
6.35	0.0 - 0.5	1.0 - 1.5	1.5 - 2.0
9.52	0.0 - 0.5	1.0 - 1.5	1.5 - 2.0
12.7	0.0 - 0.5	1.0 - 1.5	2.0 - 2.5

Use a flare tool designed for R410A or a conventional flare tool. Please note that measurement B (protrusion from the flaring block) will vary depending on the type of a flare tool in use. If a conventional flare tool is used, please use a copper pipe gauge or a similar instrument to check protrusion so that you can keep measurement B to a correct value.

Connection

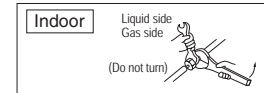

- Connect the pipes on both liquid and gas sides.
- Tighten the nuts to the following torque.
Liquid side (6.35) : 14.0 - 18.0 N·m (1.4 - 1.8 kgf·m)
Gas side (9.52) : 34.0 - 42.0 N·m (3.4 - 4.2 kgf·m) (12.7) : 49.0 - 61.0 N·m (4.9 - 6.1 kgf·m)

CAUTION
Do not apply excess torque to the flared nuts. Otherwise, the flared nuts may check depending.

Insulation of the connection portion

Cover the coupling with insulator and then cover it with tapes.

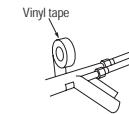

Use an attached insulation pad for heat insulation.

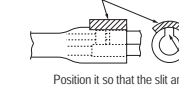

- Cover the indoor unit's flare-connected joints, after they are checked for a gas leak, with an indoor unit heat insulating material and then wrap them with a tape with an attached insulation pad placed over the heat insulating material's slit area.

Finishing work and fixing

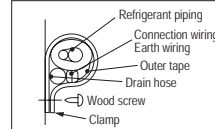

Cover the exterior portion with outer tape and shape the piping so it will match the contours of the route that the piping to take. Also fix the wiring and pipings to the wall with clamps.

Open/close and detachment/attachment of the air inlet panel

- To open, pull the panel at both ends of lower part and release latches, then pull up the panel until you feel resistance. (The panel stops at approx. 60° open position)
- To close, hold the panel at both ends of lower part to lower downward and push it slightly until the latch works.
- To remove, pull up the panel to the position shown in right illustration and pull it toward you.
- To install, insert the panel arm into the slot on the front panel from the position shown in right illustration, hold the panel at both ends of lower part, lower it downward slowly, then push it slightly until the latch works.

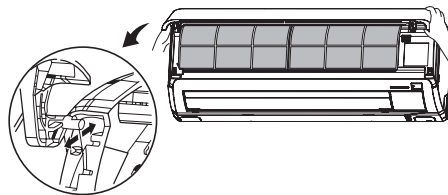

How to remove and fit the front panel

- Removing
 - Remove the air inlet panel.
 - Remove the 2 set screws.
 - Remove the 3 latches in the upper section.
 - Move the lower part of the panel forward and push upwards to remove.
- Fitting
 - Do remove the air filter.
 - Cover the body with the front panel.
 - Fit the 3 latches in the upper section.
 - Tighten the 2 set screws.
 - Fit the air filter.
 - Fit the air inlet panel.

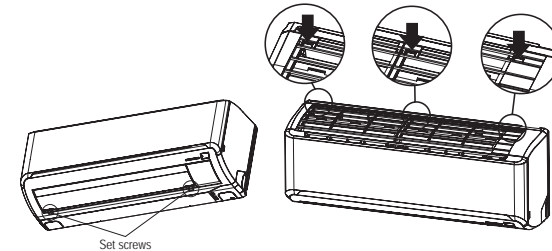

ELECTRICAL WIRING WORK

Preparation of indoor unit

Mounting of connecting wires

- ① Remove the lid.
- ② Remove the terminal cover.
- ③ Remove the wiring clamp.
- ④ Connect the connecting wire securely to the terminal block.
 - 1) Connect the connection wire securely to the terminal block. If the wire is not affixed completely, contact will be poor, and it is dangerous as the terminal block may heat up and catch fire.
 - 2) Take care not to confuse the terminal numbers for indoor and outdoor connections.
- ⑤ Fix the connecting wire by wiring clamp.
- ⑥ Attach the terminal cover.
- ⑦ Attach the lid.

CAUTION

In case of faulty wiring connection, the indoor unit stops, and then the run lamp turns on and the timer lamp blinks.

Use cables for interconnection wiring to avoid loosening of the wires.
CENELEC code for cables Required field cables.

H05RNR4G1.5 (example) or 245IEC57
 H Harmonized cable type
 05 300/500 volts
 R Natural-and/or synth, rubber wire insulation
 N Polychloroprene rubber conductors insulation
 R Stranded core
 4or5 Number of conductors
 G One conductor of the cable is the earth conductor (yellow/green)
 1.5 Section of copper wire (mm²)

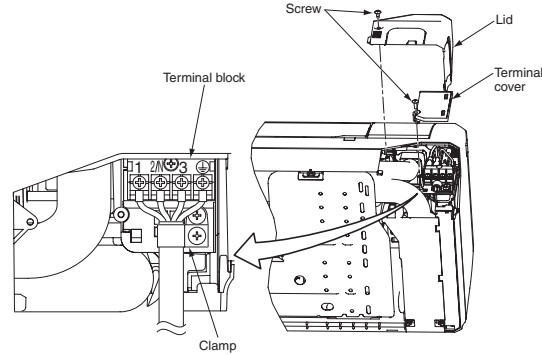

Installing the air-cleaning filters

1. Open the air inlet panel and remove the air filters.
2. Install the filter holders, with the air-cleaning filters installed in the holders. In the air conditioner.
 - Each air-cleaning filter can be installed in the left or right filter holder.
3. Install the air filters and close the inlet panel.

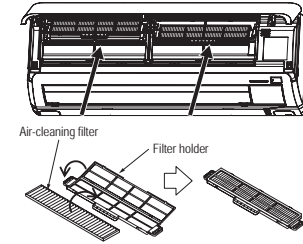

INSTALLATION OF WIRELESS CONTROL

Mounting method of battery

- Uncover the wireless remote control, and mount the batteries [R03 (AAA, Micro), ×2 pieces] in the body regularly. (Fit the poles with the indication marks, ⊕ & ⊖ without fail)

CAUTION

Do not use new and old batteries together.

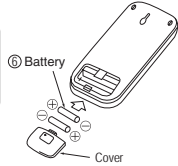

Fixing to pillar or wall

- Conventionally, operate the wireless remote control by holding in your hand.
- Avoid installing it on a clay wall etc.

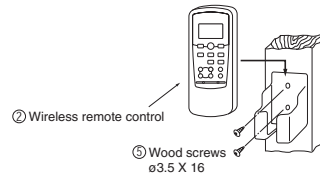

INSTALLATION TEST CHECK POINTS

Check the following points again after completion of the installation, and before turning on the power. Conduct a test run again and ensure that the unit operates properly. At the same time, explain to the customer how to use the unit and how to take care of the unit following the user's manual.

After installation

- The power supply voltage is correct as the rating.
- No gas leaks from the joints of the operation valve.
- Power cables and crossover wires are securely fixed to the terminal board.
- Operation valve is fully open.
- The pipe joints for indoor and outdoor pipes have been insulated.

Test run

- Air conditioning operation is normal.
- No abnormal noise.
- Water drains smoothly.
- Protective functions are not working.
- The remote control is normal.
- Operation of the unit has been explained to the customer. (Three-minutes restart preventive timer)
When the air conditioner is restarted or when changing the operation, the unit will not start operating for approximately 3 minutes. This is to protect the unit and it is not a malfunction.

HOW TO RELOCATE OR DISPOSE OF THE UNIT

- In order to protect the environment, be sure to pump down (recovery of refrigerant).
- Pump down is the method of recovering refrigerant from the indoor unit to the outdoor unit when the pipes are removed from the unit.

- Forced cooling operation
Turn on a power supply again after a while after turn off a power supply. Then press continually the ON/OFF button 5 seconds or more.

<How to pump down>

- ① Connect charge hose to check joint of outdoor unit.
- ② Liquid side : Close the liquid valve with hexagon wrench key.
Gas side : Fully open the gas valve.
Carry out cooling operation. (If indoor temperature is low, operate forced cooling operation.)
- ③ After low pressure gauge become 0.01MPa, stop cooling operation and close the gas valve.

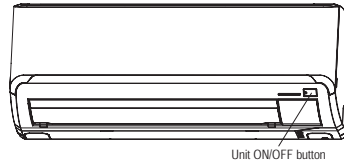

CONCERNING TERMINAL CONNECTION FOR AN INTERFACE

- ① Remove the front panel and lid of control.
- ② Remove the control.
- ③ There is a terminal (respectively marked with CNS) for the indoor control board.
In connecting an interface, connect to the respective terminal securely with the connection harness supplied with an optional "Interface connection kit SC-BIKN-E" and fasten the connection harness onto the indoor control box with the clamp supplied with the kit.
For more details, please refer to the user's manual of your "Interface connection kit SC-BIKN-E".

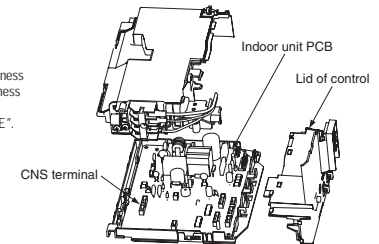

(2) Installation of outdoor unit

- This installation manual deals with outdoor units and general installation specifications only. For indoor units, refer to page 13.
- When install the unit, be sure to check whether the selection of installation place, power supply specifications, usage limitation (piping length, height differences between indoor and outdoor units, power supply voltage and etc.) and installation spaces.

SAFETY PRECAUTIONS

- We recommend you to read this “SAFETY PRECAUTIONS” carefully before the installation work in order to gain full advantage of the functions of the unit and to avoid malfunction due to mishandling.
- The precautions described below are divided into **⚠ WARNING** and **⚡ CAUTION**. The matters with possibilities leading to serious consequences such as death or serious personal injury due to erroneous handling are listed in the **⚠ WARNING** and the matters with possibilities leading to personal injury or damage of the unit due to erroneous handling including probability leading to serious consequences in some cases are listed in **⚡ CAUTION**. These are very important precautions for safety. Be sure to observe all of them without fail.
- Be sure to confirm no anomaly on the equipment by commissioning after completed installation and explain the operating methods as well as the maintenance methods of this equipment to the user according to the owner’s manual.

- Keep the installation manual together with owner’s manual at a place where any user can read at any time. Moreover if necessary, ask to hand them to a new user.
- For installing qualified personnel, take precautions in respect to themselves by using suitable protective clothing, gloves, etc., and then perform the installation works.
- Please pay attention not to fall down the tools, etc. when installing the unit at the high position.
- If unusual noise can be heard during operation, consult the dealer.
- Symbols which appear frequently in the text have the following meaning:

	Observe instructions with great care		Strictly prohibited		Provide proper earthing
--	--------------------------------------	--	---------------------	--	-------------------------

⚠ WARNING

	<ul style="list-style-type: none"> • Installation must be carried out by the qualified installer. If you install the system by yourself, it may cause serious trouble such as water leaks, electric shocks, fire and personal injury, as a result of a system malfunction. • Install the system in full accordance with the instruction manual. Incorrect installation may cause bursts, personal injury, water leaks, electric shocks and fire. • Be sure to use only for household and residence. If this appliance is installed in inferior environment such as machine shop and etc., it can cause malfunction. • Use the original accessories and the specified components for installation. If parts other than those prescribed by us are used, it may cause water leaks, electric shocks, fire and personal injury. • Install the unit in a location with good support. Unsuitable installation locations can cause the unit to fall and cause material damage and personal injury. • Ensure the unit is stable when installed, so that it can withstand earthquakes and strong winds. Unsuitable installation locations can cause the unit to fall and cause material damage and personal injury. • Ventilate the working area well in the event of refrigerant leakage during installation. If the refrigerant comes into contact with naked flames, poisonous gas is produced. • Use the prescribed pipes, flare nuts and tools for R410A. Using existing parts (for R22 or R407C) can cause the unit failure and serious accidents due to burst of the refrigerant circuit. 	<ul style="list-style-type: none"> • Tighten the flare nut by torque wrench with specified method. If the flare nut were tightened with excess torque, this may cause burst and refrigerant leakage after a long period. • Do not open the operation valves for liquid line and gas line until completed refrigerant piping work, air tightness test and evacuation. If the compressor is operated in state of opening operation valves before completed connection of refrigerant piping work, air can be sucked into refrigerant circuit, which can cause burst or personal injury due to anomalously high pressure in the refrigerant. • The electrical installation must be carried out by the qualified electrician in accordance with “the norm for electrical work” and “national wiring regulation”, and the system must be connected to the dedicated circuit. Power supply with insufficient capacity and incorrect function done by improper work can cause electric shocks and fire. • Be sure to shut off the power before starting electrical work. Failure to shut off the power can cause electric shocks, unit failure or incorrect function of equipment. • Be sure to use the cables conformed to safety standard and cable ampacity for power distribution work. Unconformable cables can cause electric leak, anomalous heat production or fire. • This appliance must be connected to main power supply by means of a circuit breaker or switch (fuse:16A) with a contact separation of at least 3mm. 	<ul style="list-style-type: none"> • Use the prescribed cables for electrical connection, tighten the cables securely in terminal block and relieve the cables correctly to prevent overloading the terminal blocks. Loose connections or cable mountings can cause anomalous heat production or fire. • Arrange the wiring in the control box so that it cannot be pushed up further into the box. Install the service panel correctly. Incorrect installation may result in overheating and fire. • Be sure to fix up the service panels. Incorrect fixing can cause electric shocks or fire due to intrusion of dust or water. • Be sure to switch off the power supply in the event of installation, inspection or servicing. If the power supply is not shut off, there is a risk of electric shocks, unit failure or personal injury due to the unexpected start of fan. • Stop the compressor before disconnecting refrigerant pipes in case of pump down operation. If disconnecting refrigerant pipes in state of opening operation valves before compressor stopping, air can be sucked, which can cause burst or personal injury due to anomalously high pressure in the refrigerant circuit • Only use prescribed optional parts. The installation must be carried out by the qualified installer. If you install the system by yourself, it can cause serious trouble such as water leaks, electric shocks, fire.
	<ul style="list-style-type: none"> • Ensure that no air enters in the refrigerant circuit when the unit is installed and removed. If air enters in the refrigerant circuit, the pressure in the refrigerant circuit becomes too high, which can cause burst and personal injury. • Do not processing, splice the power cord, or share a socket with other power plugs. This may cause fire or electric shock due to defecting contact, defecting insulation and over-current etc. 	<ul style="list-style-type: none"> • Do not bundling, winding or processing for the power cord. Or, do not deforming the power plug due to tread it. This may cause fire or heating. • Do not run the unit with removed panels or protections. Touching rotating equipments, hot surfaces or high voltage parts can cause personal injury due to entrapment, burn or electric shocks. 	<ul style="list-style-type: none"> • Do not perform any change of protective device itself or its setup condition. The forced operation by short-circuiting protective device of pressure switch and temperature controller or the use of non specified component can cause fire or burst.
	<ul style="list-style-type: none"> • Carry out the electrical work for ground lead with care. Do not connect the ground lead to the gas line, water line, lightning conductor or telephone line’s ground lead. Incorrect grounding can cause unit faults such as electric shocks due to short-circuiting. 		

⚠ CAUTION

!	<ul style="list-style-type: none"> • Use the circuit breaker with sufficient breaking capacity. If the breaker does not have sufficient breaking capacity, it can cause the unit malfunction and fire. • Earth leakage breaker must be installed. If the earth leakage breaker is not installed, it can cause electric shocks. • Install isolator or disconnect switch on the power supply wiring in accordance with the local codes and regulations. • After maintenance, all wiring, wiring ties and the like, should be returned to their original state and wiring route, and the necessary clearance from all metal parts should be secured. • Secure a space for installation, inspection and maintenance specified in the manual. Insufficient space can result in accident such as personal injury due to falling from the installation place. 	<ul style="list-style-type: none"> • Take care when carrying the unit by hand. If the unit weights more than 20kg, it must be carried by two or more persons. Do not carry by the plastic straps, always use the carry handle when carrying the unit by hand. Use gloves to minimize the risk of cuts by the aluminum fins. • Dispose of any packing materials correctly. Any remaining packing materials can cause personal injury as it contains nails and wood. And to avoid danger of suffocation, be sure to keep the plastic wrapper away from children and to dispose after tear it up. • Be sure to insulate the refrigerant pipes so as not to condense the ambient air moisture on them. Insufficient insulation can cause condensation, which can lead to moisture damage on the ceiling, floor, furniture and any other valuables. 	<ul style="list-style-type: none"> • When perform the air conditioner operation (cooling or drying operation) in which ventilator is installed in the room. In this case, using the air conditioner in parallel with the ventilator, there is the possibility that drain water may backflow in accordance with the room lapse into the negative pressure status. Therefore, set up the opening port such as incorporate the air into the room that may appropriate to ventilation (For example; Open the door a little). In addition, just as above, so set up the opening port if the room lapse into negative pressure status due to register of the wind for the high rise apartment etc.
⊘	<ul style="list-style-type: none"> • Do not install the unit in the locations listed below. <ul style="list-style-type: none"> • Locations where carbon fiber, metal powder or any powder is floating. • Locations where any substances that can affect the unit such as sulphide gas, chloride gas, acid and alkaline can occur. • Vehicles and ships. • Locations where cosmetic or special sprays are often used. • Locations with direct exposure of oil mist and steam such as kitchen and machine plant. • Locations where any machines which generate high frequency harmonics are used. • Locations with salty atmospheres such as coastlines. • Locations with heavy snow (If installed, be sure to provide base flame and snow hood mentioned in the manual). • Locations where the unit is exposed to chimney smoke. • Locations at high altitude (more than 1000m high). • Locations with ammoniac atmospheres. • Locations where heat radiation from other heat source can affect the unit. • Locations without good air circulation. • Locations with any obstacles which can prevent inlet and outlet air of the unit. • Locations where short circuit of air can occur (in case of multiple units installation). • Locations where strong air blows against the air outlet of outdoor unit. It can cause remarkable decrease in performance, corrosion and damage of components, malfunction and fire. 	<ul style="list-style-type: none"> • Do not install the outdoor unit in the locations listed below. <ul style="list-style-type: none"> • Locations where discharged hot air or operating sound of the outdoor unit can bother neighborhood. • Locations where outlet air of the outdoor unit blows directly to plants. • Locations where vibration can be amplified and transmitted due to insufficient strength of structure. • Locations where vibration and operation sound generated by the outdoor unit can affect seriously (on the wall or at the place near bed room). • Locations where an equipment affected by high harmonics is placed (TV set or radio receiver is placed within 5m). • Locations where drainage cannot run off safely. It can affect surrounding environment and cause a claim. • Do not install the unit near the location where leakage of combustible gases can occur. If leaked gases accumulate around the unit, it can cause fire. • Do not install the unit where corrosive gas (such as sulfuric acid gas etc.) or combustible gas (such as thinner and petroleum gases) can accumulate or collect, or where volatile combustible substances are handled. Corrosive gas can cause corrosion of heat exchanger, breakage of plastic parts and etc. And combustible gas can cause fire. • Do not install nor use the system close to the equipment that generates electromagnetic fields or high frequency harmonics. Equipment such as inverters, standby generators, medical high frequency equipments and telecommunication equipments can affect 	<p>the system, and cause malfunctions and breakdowns. The system can also affect medical equipment and telecommunication equipment, and obstruct its function or cause jamming.</p> <ul style="list-style-type: none"> • Do not install the outdoor unit in a location where insects and small animals can inhabit. Insects and small animals can enter the electric parts and cause damage or fire. Instruct the user to keep the surroundings clean. • Do not use the base flame for outdoor unit which is corroded or damaged due to long periods of operation. Using an old and damage base flame can cause the unit falling down and cause personal injury. • Do not use any materials other than a fuse with the correct rating in the location where fuses are to be used. Connecting the circuit with copper wire or other metal thread can cause unit failure and fire. • Do not touch any buttons with wet hands. It can cause electric shocks. • Do not touch any refrigerant pipes with your hands when the system is in operation. During operation the refrigerant pipes become extremely hot or extremely cold depending the operating condition, and it can cause burn injury or frost injury. • Do not touch the suction or aluminum fin on the outdoor unit. This may cause injury. • Do not put anything on the outdoor unit and operating unit. This may cause damage the objects or injury due to falling to the object.

Check before installation work

- Model name and power source
- Refrigerant piping length
- Piping, wiring and miscellaneous small parts
- Indoor unit installation manual

Accessories for outdoor unit	Q'ty
① Grommet (Heat pump type only)	1
② Drain elbow (Heat pump type only)	1

Option parts	Q'ty
Ⓐ Sealing plate	1
Ⓑ Sleeve	1
Ⓒ Inclination plate	1
Ⓓ Putty	1
Ⓔ Drain hose (extension hose)	1
① Piping cover (for insulation of connection piping)	1

Necessary tools for the installation work	Q'ty	Description
	9	Wrench key (Hexagon) [4m/m]
	10	Vacuum pump
1 Plus headed driver	11	Vacuum pump adapter (Anti-reverse flow type) (Designed specifically for R410A)
2 Knife	12	Gauge manifold (Designed specifically for R410A)
3 Saw	13	Charge hose (Designed specifically for R410A)
4 Tape measure	14	Flaring tool set (Designed specifically for R410A)
5 Hammer	15	Gas leak detector (Designed specifically for R410A)
6 Spanner wrench	16	Gauge for projection adjustment
7 Torque wrench [14.0~62.0N·m (1.4~6.2kgf·m)]		(Used when flare is made by using conventional flare tool)
8 Hole core drill (65mm in diameter)		

Notabilia as a unit designed for R410A

- Do not use any refrigerant other than R410A. R410A will rise to pressure about 1.6 times higher than that of a conventional refrigerant. A cylinder containing R410A has a pink indication mark on the top.
- A unit designed for R410A has adopted a different size indoor unit operation valve charge port and a different size check joint provided in the unit to prevent the charging of a wrong refrigerant by mistake. The processed dimension of the flared part of a refrigerant pipe and a flare nut's parallel side measurement have also been altered to raise strength against pressure. Accordingly, you are required to arrange dedicated R410A tools listed in the table on the right before installing or servicing this unit.
- Do not use a charge cylinder. The use of a charge cylinder will cause the refrigerant composition to change, which results in performance degradation.
- In charging refrigerant, always take it out from a cylinder in the liquid phase.
- All indoor units must be models designed exclusively for R410A. Check connectable indoor unit models in a catalog, etc. (A wrong indoor unit, if connected into the system, will impair proper system operation)

1. HAULAGE AND INSTALLATION (Take particular care in carrying in or moving the unit, and always perform such an operation with two or more persons.)

CAUTION When a unit is hoisted with slings for haulage, take into consideration the offset of its gravity center position. If not properly balanced, the unit can be thrown off-balance and fall.

1) Delivery

- Deliver the unit as close as possible to the installation site before removing it from the packaging.
- When you have to unpack the unit for a compelling reason before you haul it to the installation point, hoist the unit with nylon slings or ropes and protection pads so that you may not damage the unit.

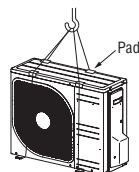

2) Portage

- The right hand side of the unit as viewed from the front (diffuser side) is heavier. A person carrying the right hand side must take heed of this fact. A person carrying the left hand side must hold with his right hand the handle provided on the front panel of the unit and with his left hand the corner column section.

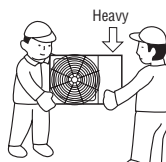

3) Selecting the installation location

Be careful of the following conditions and choose an installation place.

- Where air is not trapped.
- Where the installation fittings can be firmly installed.
- Where wind does not hinder the intake and outlet pipes.
- Out of the heat range of other heat sources.
- A place where stringent regulation of electric noises is applicable.
- Where it is safe for the drain water to be discharged.
- Where noise and hot air will not bother neighboring residents.
- Where snow will not accumulate.
- Where strong winds will not blow against the outlet pipe.
- A place where no TV set or radio receiver is placed within 5m. (If electrical interference is caused, seek a place less likely to cause the problem)
- If a operation is conducted when the outdoor air temperature is -5°C lower, the outdoor unit should be installed at a place where it is not influenced by natural wind.
- Where it is likely that the unit is subjected to strong winds, provide wind guards according to the following guidelines. Strong winds can cause performance degradation, an accidental stop due to a rise of high pressure and a broken fan.

1. Place the unit outlet pipe perpendicular to the wind direction.

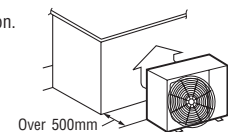

2. Install so the direction of the air from the blowing outlet will be perpendicular to the direction of the wind.

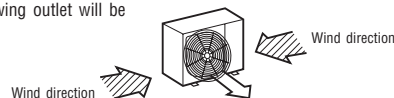

4) Installation space

- Walls surrounding the unit in the four sides are not acceptable.
- There must be a 1-meter or larger space in the above.
- When more than one unit are installed side by side, provide a 250mm or wider interval between them as a service space. In order to facilitate servicing of controllers, please provide a sufficient space between units so that their top plates can be removed easily.
- Where a danger of short-circuiting exists, install guide louvers.
- When more than one unit are installed, provide sufficient intake space consciously so that short-circuiting may not occur.
- Where piling snow can bury the outdoor unit, provide proper snow guards.

Size	Example installation	Model 20, 25, 35 (mm)			
		I	II	III	IV
L1	Open	280	280	180	
L2	100	75	Open	Open	
L3	100	80	80	80	
L4	250	Open	250	Open	

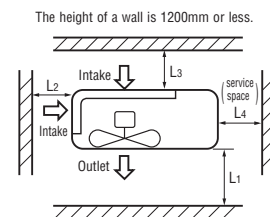

5) Installation

① Anchor bolt fixed position

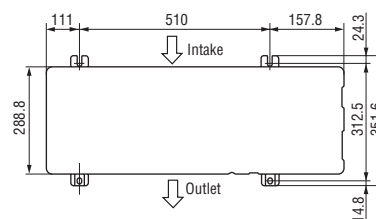

② Notabilia for installation

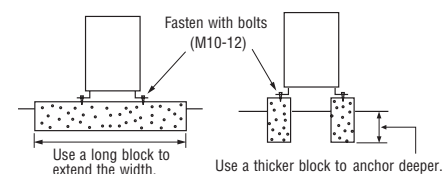

- In installing the unit, fix the unit's legs with bolts specified on the left.
 - The protrusion of an anchor bolt on the front side must be kept within 15 mm.
 - Securely install the unit so that it does not fall over during earthquakes or strong winds, etc.
 - Refer to the above illustrations for information regarding concrete foundations.
 - Install the unit in a level area. (With a gradient of 5 mm or less.)
- Improper installation can result in a compressor failure, broken piping within the unit and abnormal noise generation.

2. REFRIGERANT PIPING WORK

1) Restrictions on unit installation and use

- Check the following points in light of the indoor unit specifications and the installation site.
- Observe the following restrictions on unit installation and use. Improper installation can result in a compressor failure or performance degradation.
- Additional refrigerant charge is not required at all.

Restrictions		Dimensional restrictions	Marks appearing in the drawing on the right
Main pipe length		15m or less	L
Elevation difference between indoor and outdoor units	When the outdoor unit is positioned higher,	10m or less	H
	When the outdoor unit is positioned lower,	10m or less	H

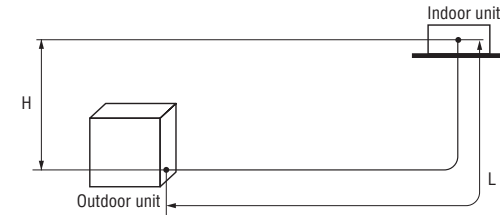

CAUTION ● The use restrictions appearing in the table above are applicable to the standard pipe size combinations shown in the table below.

2) Determination of pipe size

- Determine refrigerant pipe size pursuant to the following guidelines based on the indoor unit specifications.

	Model 20, 25, 35	
	Gas pipe	Liquid pipe
Outdoor unit connected	φ 9.52 Flare	φ 6.35 Flare
Refrigerant piping (branch pipe)L	φ 9.52	φ 6.35
Indoor unit connected	φ 9.52	φ 6.35

When pipe is brazing.

About brazing

Brazing must be performed under a nitrogen gas flow.

Without nitrogen gas, a large quantity of foreign matters (oxidized film) are created, causing a critical failure from capillary tube or expansion valve clogging.

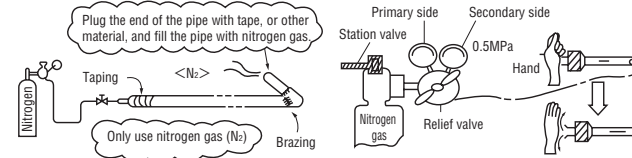

3) Refrigerant pipe wall thickness and material

- Select refrigerant pipes of the table shown on the right wall thickness and material as specified for each pipe size.

NOTE ● Select pipes having a wall thickness larger than the specified minimum pipe thickness.

Pipe diameter [mm]	6.35	9.52
Minimum pipe wall thickness [mm]	0.8	0.8
Pipe material*	O-type pipe	O-type pipe

*Phosphorus deoxidized seamless copper pipe ICS 23.040.15, ICS 77.150.30

4) On-site piping work

IMPORTANT Take care so that installed pipes may not touch components within a unit. If touching with an internal component, it will generate abnormal sounds and/or vibrations.

How to remove the side cover Please remove the screw of a side cover and remove to the front.

- Carry out the on site piping work with the operation valve fully closed.
- Give sufficient protection to a pipe end (compressed and blazed, or with an adhesive tape) so that water or foreign matters may not enter the piping.
- Bend a pipe to a radius as large as practical.(R100~R150) Do not bend a pipe repeatedly to correct its form.
- Flare connection is used between the unit and refrigerant pipe. Flare a pipe after engaging a flare nut onto it. Flare dimensions for R410A are different from those for conventional R407C. Although we recommend the use of flaring tools designed specifically for R410A, conventional flaring tools can also be used by adjusting the measurement of protrusion B with a protrusion control gauge.
- Tighten a flare joint securely.

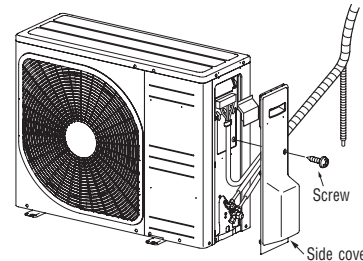

Flared pipe end : A (mm)	
Copper pipe outer diameter	A 0 -0.4
φ6.35	9.1
φ9.52	13.2

Copper pipe protrusion for flaring : B (mm)		
Copper pipe outer diameter	In the case of a rigid (clutch) type	
	With an R410A tool	With a conventional tool
φ6.35	0~0.5	1.0~1.5
φ9.52		

CAUTION Do not apply force beyond proper fastening torque in tightening the flare nut.

Fix both liquid and gas operation valves at the valve main bodies as illustrated on the right, and then fasten them, applying appropriate fastening torque.

Operation valve size (mm)	Tightening torque (N-m)	Tightening angle (°)	Recommended length of a tool handle (mm)
φ6.35 (1/4")	14~18	45~60	150
φ9.52 (3/8")	34~42	30~45	200

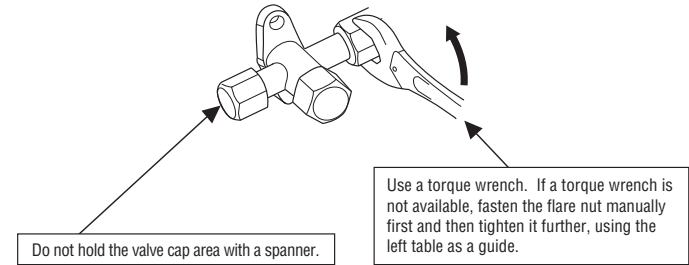

5) Air tightness test

- Although outdoor and indoor units themselves have been tested for air tightness at the factory, check the connecting pipes after the installation work for air tightness from the operation valve's check joint equipped on the outdoor unit side. While conducting a test, keep the operation valve shut all the time.
 - Raise the pressure to 0.5 MPa, and then stop. Leave it for five minutes to see if the pressure drops.
 - Then raise the pressure to 1.5 MPa, and stop. Leave it for five more minutes to see if the pressure drops.
 - Then raise the pressure to the specified level (4.15 MPa), and record the ambient temperature and the pressure.
 - If no pressure drop is observed with an installation pressurized to the specified level and left for about one day, it is acceptable. When the ambient Temperature fall 1°C, the pressure also fall approximately 0.01 MPa. The pressure, if changed, should be compensated for.
 - If a pressure drop is observed in checking e) and a) – d), a leak exists somewhere. Find a leak by applying bubble test liquid to welded parts and flare joints and repair it. After repair, conduct an air-tightness test again.
- In conducting an air-tightness test, use nitrogen gas and pressurize the system with nitrogen gas from the gas side. Do not use a medium other than nitrogen gas under any circumstances.

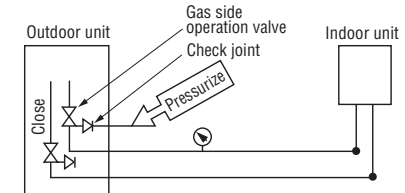

6) Evacuation

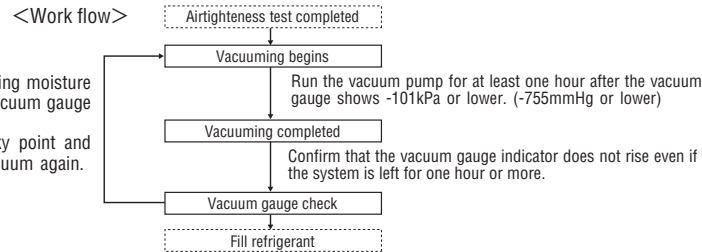

When the system has remaining moisture inside or a leaky point, the vacuum gauge indicator will rise. Check the system for a leaky point and then draw air to create a vacuum again.

Pay attention to the following points in addition to the above for the R410A and compatible machines.

- To prevent a different oil from entering, assign dedicated tools, etc. to each refrigerant type. Under no circumstances must a gauge manifold and a charge hose in particular be shared with other refrigerant types (R22, R407C, etc.).
- Use a counterflow prevention adapter to prevent vacuum pump oil from entering the refrigerant system.

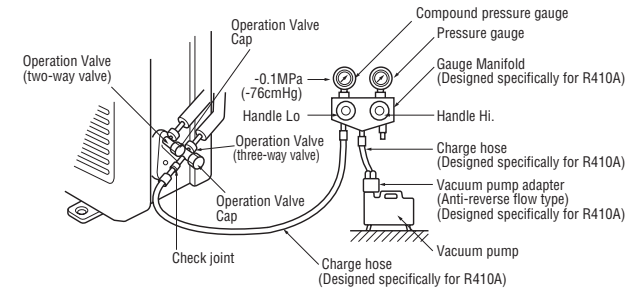

Securely tighten the operation valve cap and the check joint blind nut after adjustment.

Operation valve size (mm)	Operation valve cap tightening torque (N-m)	Check joint blind nut tightening torque (N-m)
φ6.35 (1/4")	20~30	10~12
φ9.52 (3/8")		

7) Heating and condensation prevention

- Dress refrigerant pipes (both gas and liquid pipes) for heat insulation and prevention of dew condensation.
 - Improper heat insulation/anti-dew dressing can result in a water leak or dripping causing damage to household effects, etc.
- Use a heat insulating material that can withstand 120°C or a higher temperature. Poor heat insulating capacity can cause heat insulation problems or cable deterioration.
 - All gas pipes must be securely heat insulated in order to prevent damage from dripping water that comes from the condensation formed on them during a cooling operation or personal injury from burns because their surface can reach quite a high temperature due to discharged gas flowing inside during a heating operation.
 - Wrap indoor units' flare joints with heat insulating parts (pipe cover) for heat insulation (both gas and liquid pipes).
 - Give heat insulation to both gas and liquid side pipes. Bundle a heat insulating material and a pipe tightly together so that no gaps may be left between them and wrap them together with a connecting cable by a dressing tape.
 - Both gas and liquid pipes need to be dressed with 20 mm or thicker heat insulation materials above the ceiling where relative humidity exceeds 70%.**

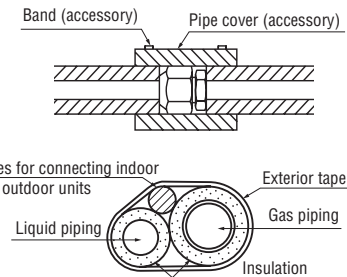

3. DRAIN PIPING WORK

- Execute drain piping by using a drain elbow and drain grommets supplied separately as optional parts, where water drained from the outdoor unit is a problem.
- Water may drip where there is a larger amount of drain water. Seal around the drain elbow and drain grommets with putty or adequate caulking material.
- Condensed water may flow out from vicinity of operation valve or connected pipes.
- Where you are likely to have several days of sub-zero temperatures in a row, do not use a drain elbow and drain grommets. (There is a risk of drain water freezing inside and blocking the drain.)

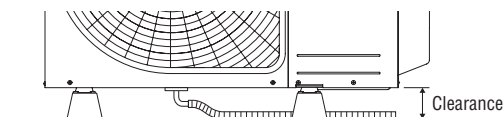
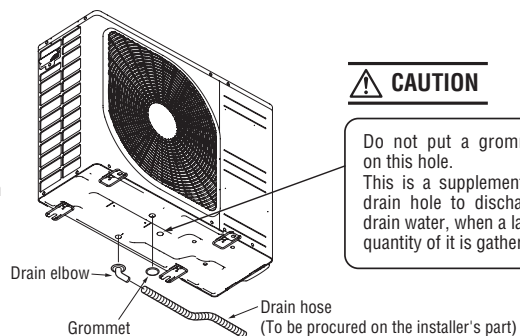

- When condensed water needs to be led to a drain, etc., install the unit on a flat base (supplied separately as an optional part) or concrete blocks. Then, please secure space for the drain elbow and the drain hose.

4. ELECTRICAL WIRING WORK For details of electrical cabling, refer to the indoor unit installation manual.

Electrical installation work must be performed by an electrical installation service provider qualified by a power provider of the country. Electrical installation work must be executed according to the technical standards and other regulations applicable to electrical installations in the country.

- Do not use any supply cord lighter than one specified in parentheses for each type below.
 - braided cord (code designation 60245 IEC 51),
 - ordinary tough rubber sheathed cord (code designation 60245 IEC 53)
 - flat twin tinsel cord (code designation 60227 IEC 41);
 Use polychloroprene sheathed flexible cord (code designation 60245 IEC57) for supply cords of parts of appliances for outdoor use.
- Ground the unit. Do not connect the grounding wire to a gas pipe, water pipe, lightning rod or telephone grounding wire. If improperly grounded, an electric shock or malfunction may result.
- A grounding wire must be connected before connecting the power cable. Provide a grounding wire longer than the power cable.
- The installation of an impulse withstanding type earth leakage breaker is necessary. A failure to install an earth leakage breaker can result in an accident such as an electric shock or a fire.
- Do not turn on the power until the electrical work is completed.
- Do not use a condensive capacitor for power factor improvement under any circumstances. (It does not improve power factor, while it can cause an abnormal overheat accident)
- For power supply cables, use conduits.
- Do not lay electronic control cables (remote control and signaling wires) and other cables together outside the unit. Laying them together can result in the malfunctioning or a failure of the unit due to electric noises.
- Fasten cables so that they may not touch the piping, etc.
- When cables are connected, make sure that all electrical components within the electrical component box are free of loose connector coupling or terminal connection and then attach the cover securely. (Improper cover attachment can result in malfunctioning or a failure of the unit, if water penetrates into the box.)
- Always use a three-core cable for an indoor-outdoor connecting cable. Never use a shield cable.

CAUTION

In case of faulty wiring connection, the indoor unit stops, and then the run lamp turns on and the timer lamp blinks.

Use cables for interconnection wiring to avoid loosening of the wires. CENELEC code for cables Required field cables.

H05RNR4G1.5 (Example) or 245IEC57	
H	Harmonized cable type
05	300/500 volts
R	Natural-and/or synth. rubber wire insulation
N	Polychloroprene rubber conductors insulation
R	Stranded core
4or5	Number of conductors
G	One conductor of the cable is the earth conductor (yellow/green)
1.5	Section of copper wire (mm ²)

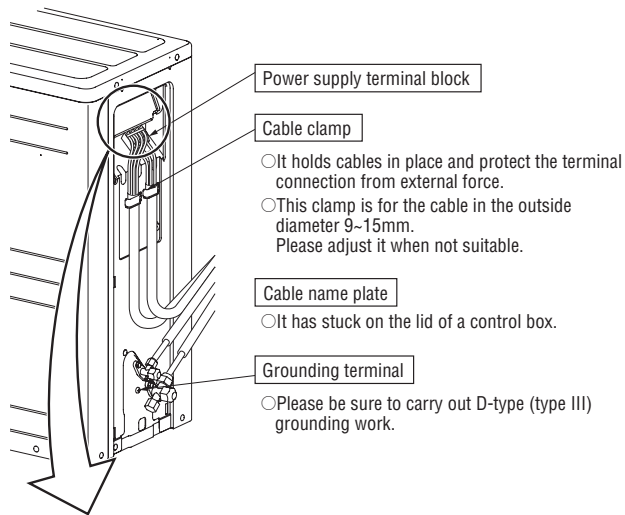

Power cable, indoor-outdoor connecting wires

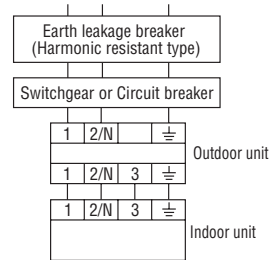

● Always perform grounding system installation work with the power cord unplugged.

CAUTION Always use an earth leakage circuit breaker designed for inverter circuits to prevent a faulty operation.

Phase	Model	Earth leakage breaker	Switchgear or Circuit Breaker		Power source (minimum)	Interconnecting and grounding wires (minimum)
			Switch breaker	Over current protector rated capacity		
Single-phase	20	15A,30mA, 0.1sec or less	30A	16A	2.0mm ²	1.5mm ² ×4
	25					
	35					

- The specifications shown in the above table are for units without heaters. For units with heaters, refer to the installation instructions or the construction instructions of the indoor unit.
- Switchgear or Circuit breaker capacity which is calculated from MAX. over current should be chosen along the regulations in each country.
- The cable specifications are based on the assumption that a metal or plastic conduit is used with no more than three cables contained in a conduit and a voltage drop is 2%. For an installation falling outside of these conditions, please follow the internal cabling regulations. Adapt it to the regulation in effect in each country.

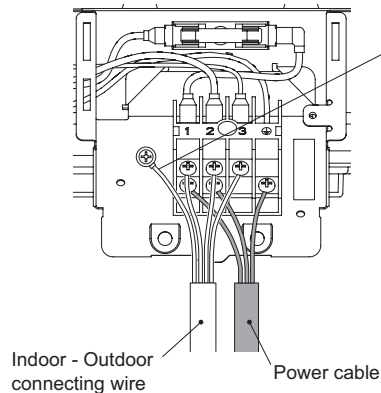

CAUTION
Please connect the earthed line of indoor and outdoor connecting wire to a bracket part of the illustration.

power cable, indoor - outdoor connecting wire circuit diagram

INSTALLATION TEST CHECK POINTS

Check the following points again after completion of the installation, and before turn on the power. Conduct a test run again and ensure that the unit operates properly. Explain to the customer how to use the unit and how to take care of the unit following the instruction manual.

After installation

- | | |
|--|---|
| <input type="checkbox"/> Power cables and connecting wires are securely fixed to the terminal block. | <input type="checkbox"/> The pipe joints for indoor and outdoor pipes have been insulated. |
| <input type="checkbox"/> The power supply voltage is correct as the rating. | <input type="checkbox"/> The reverse flow check cap is attached. |
| <input type="checkbox"/> The drain hose is fixed securely. | <input type="checkbox"/> The cover of the pipe cover (A) faces downward to prevent rain from entering. |
| <input type="checkbox"/> Operational valve is fully open. | <input type="checkbox"/> Gaps are properly sealed between the pipe covers (A) (B) and the wall surface / pipes. |
| <input type="checkbox"/> No gas leaks from the joints of the operational valve. | |

7 RANGE OF USAGE & LIMITATIONS

Item	Models	SRK20ZJ-S, 25ZJ-S, 35ZJ-S
Indoor return air temperature (Upper, lower limits)		Cooling operation : Approximately 18 to 32°C D.B. Heating operation : Approximately 10 to 27°C D.B. (Refer to the selection chart)
Outdoor air temperature (Upper, lower limits)		Cooling operation : Approximately -15 to 46°C D.B. Heating operation : Approximately -15 to 21°C D.B. (Refer to the selection chart)
Refrigerant line (one way) length		Max. 15m
Vertical height difference between outdoor unit and indoor unit		Max. 10m (Outdoor unit is higher) Max. 10m (Outdoor unit is lower)
Power source voltage		Rating ±10%
Voltage at starting		Min. 85% of rating
Frequency of ON-OFF cycle		Max. 4 times/h (Inching prevention 10 minutes)
ON and OFF interval		Min. 3 minutes

Selection chart

Correct the cooling and heating capacity in accordance with the conditions as follows. The net cooling and heating capacity can be obtained in the following way.

Net capacity = Capacity shown on specification × Correction factors as follows.

(1) Coefficient of cooling and heating capacity in relation to temperatures

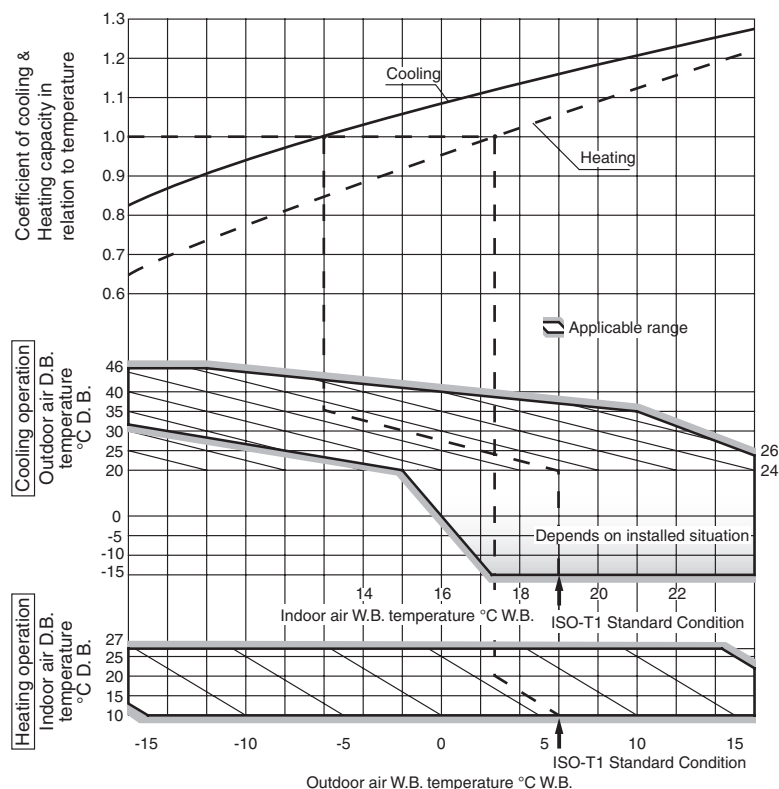

(2) Correction of cooling and heating capacity in relation to one way length of refrigerant piping

It is necessary to correct the cooling and heating capacity in relation to the one way piping length between the indoor and outdoor units.

Piping length [m]	7	10	15	20	25	30
Cooling	1.0	0.99	0.975	0.965	0.95	0.935
Heating	1.0	1.0	1.0	1.0	1.0	1.0

(3) Correction relative to frosting on outdoor heat exchanger during heating

In additions to the foregoing corrections (1), (2) the heating capacity needs to be adjusted also with respect to the frosting on the outdoor heat exchanger.

Air inlet temperature of outdoor unit in °CWB	-15	-10	-9	-7	-5	-3	-1	1	3	5 or more
Adjustment coefficient	0.95	0.95	0.94	0.93	0.91	0.88	0.86	0.87	0.92	1.00

How to obtain the cooling and heating capacity

Example : The net cooling capacity of the model SRK35ZJ-S with the piping length of 15m, indoor wet-bulb temperature at 19.0°C and outdoor dry-bulb temperature 35°C is Net cooling capacity =

$$\begin{array}{ccccccc}
 \frac{3500}{\uparrow} & \times & \frac{0.975}{\uparrow} & \times & \frac{1.0}{\uparrow} & = & 3413 \text{ W} \\
 \text{SRK35ZJ-S} & & \text{Length 15m} & & \text{Factor by air} & & \\
 & & & & \text{temperatures} & &
 \end{array}$$

8 CAPACITY TABLES

Model SRK20ZJ-S

Cool Mode

Air flow	Outdoor air temp.	Indoor air temp													
		21°CDB		23°CDB		26°CDB		27°CDB		28°CDB		31°CDB		33°CDB	
		14°CWB	16°CWB	18°CWB	19°CWB	20°CWB	22°CWB	24°CWB	TC	SHC	TC	SHC	TC	SHC	TC
Hi 7.8 (m³/min)	10	2.25	1.93	2.36	1.90	2.45	1.99	2.49	1.96	2.53	1.94	2.60	2.02	2.67	1.97
	12	2.21	1.91	2.32	1.88	2.41	1.97	2.45	1.95	2.50	1.93	2.58	2.01	2.65	1.96
	14	2.17	1.89	2.28	1.86	2.38	1.96	2.42	1.94	2.47	1.91	2.55	2.00	2.62	1.95
	16	2.13	1.87	2.24	1.85	2.34	1.94	2.39	1.92	2.43	1.90	2.52	1.99	2.59	1.94
	18	2.08	1.85	2.19	1.82	2.30	1.92	2.35	1.90	2.40	1.88	2.49	1.98	2.56	1.93
	20	2.04	1.83	2.15	1.81	2.26	1.91	2.31	1.89	2.36	1.87	2.45	1.97	2.53	1.92
	22	1.99	1.81	2.10	1.78	2.22	1.89	2.28	1.88	2.32	1.86	2.42	1.95	2.50	1.91
	24	1.94	1.78	2.05	1.76	2.18	1.88	2.24	1.86	2.28	1.85	2.38	1.94	2.47	1.90
	26	1.90	1.76	2.01	1.74	2.14	1.86	2.20	1.85	2.24	1.83	2.35	1.93	2.43	1.89
	28	1.85	1.74	1.96	1.72	2.09	1.84	2.15	1.83	2.20	1.82	2.31	1.92	2.40	1.88
	30	1.79	1.71	1.90	1.70	2.05	1.83	2.11	1.82	2.16	1.80	2.27	1.90	2.36	1.87
	32	1.74	1.69	1.85	1.68	2.00	1.81	2.07	1.80	2.12	1.79	2.23	1.89	2.32	1.86
	34	1.69	1.66	1.80	1.65	1.95	1.79	2.02	1.78	2.07	1.77	2.19	1.88	2.28	1.85
	35	1.66	1.65	1.77	1.64	1.93	1.78	2.00	1.78	2.05	1.76	2.17	1.87	2.26	1.84
	36	1.63	1.63	1.74	1.62	1.90	1.77	1.98	1.77	2.02	1.75	2.15	1.87	2.24	1.83
	38	1.58	1.58	1.68	1.60	1.85	1.75	1.93	1.75	1.98	1.74	2.11	1.85	2.20	1.82
	39	1.55	1.55	1.66	1.59	1.83	1.74	1.91	1.74	1.95	1.73	2.08	1.84	2.18	1.81

Heat Mode

Air flow	outdoor air temp.	Indoor air temp				
		16°CDB	18°CDB	20°CDB	22°CDB	24°CDB
		Hi 9.8 (m³/min)	-15°CWB	1.66	1.63	1.59
-10°CWB	1.88		1.85	1.82	1.78	1.74
-5°CWB	2.04		2.01	1.97	1.94	1.91
0°CWB	2.13		2.10	2.07	2.04	2.01
5°CWB	2.72		2.69	2.67	2.62	2.58
6°CWB	2.76		2.73	2.70	2.67	2.63
10°CWB	2.94		2.91	2.89	2.85	2.82
15°CWB	3.20		3.17	3.14	3.11	3.08
20°CWB	3.43	3.41	3.39	3.35	3.32	

Model SRK25ZJ-S

Cool Mode

Air flow	Outdoor air temp.	Indoor air temp													
		21°CDB		23°CDB		26°CDB		27°CDB		28°CDB		31°CDB		33°CDB	
		14°CWB	16°CWB	18°CWB	19°CWB	20°CWB	22°CWB	24°CWB	TC	SHC	TC	SHC	TC	SHC	TC
Hi 7.9 (m³/min)	10	2.82	2.23	2.95	2.19	3.06	2.27	3.11	2.24	3.16	2.21	3.26	2.28	3.34	2.21
	12	2.77	2.20	2.90	2.17	3.01	2.25	3.07	2.22	3.12	2.20	3.22	2.27	3.31	2.20
	14	2.71	2.17	2.85	2.14	2.97	2.23	3.03	2.21	3.08	2.18	3.18	2.25	3.28	2.19
	16	2.66	2.15	2.80	2.12	2.92	2.21	2.98	2.19	3.04	2.16	3.15	2.24	3.24	2.18
	18	2.60	2.12	2.74	2.09	2.88	2.19	2.94	2.17	2.99	2.14	3.11	2.22	3.20	2.17
	20	2.55	2.09	2.68	2.07	2.83	2.17	2.89	2.14	2.95	2.12	3.07	2.21	3.17	2.15
	22	2.49	2.06	2.63	2.04	2.78	2.14	2.84	2.12	2.90	2.10	3.02	2.20	3.13	2.14
	24	2.43	2.03	2.57	2.01	2.72	2.12	2.80	2.11	2.85	2.08	2.98	2.18	3.08	2.13
	26	2.37	2.00	2.51	1.98	2.67	2.10	2.74	2.09	2.80	2.07	2.93	2.16	3.04	2.11
	28	2.31	1.97	2.44	1.96	2.61	2.08	2.69	2.07	2.75	2.05	2.89	2.14	3.00	2.10
	30	2.24	1.94	2.38	1.92	2.56	2.05	2.64	2.05	2.70	2.03	2.84	2.13	2.95	2.08
	32	2.18	1.91	2.31	1.89	2.50	2.03	2.58	2.03	2.64	2.01	2.79	2.11	2.90	2.07
	34	2.11	1.88	2.25	1.87	2.44	2.01	2.53	2.00	2.59	1.99	2.74	2.09	2.85	2.05
	35	2.08	1.87	2.21	1.85	2.41	1.99	2.50	1.99	2.56	1.97	2.71	2.08	2.83	2.04
	36	2.04	1.85	2.18	1.84	2.38	1.98	2.47	1.98	2.53	1.96	2.69	2.08	2.80	2.03
	38	1.97	1.82	2.11	1.81	2.32	1.96	2.41	1.96	2.47	1.94	2.63	2.05	2.75	2.02
	39	1.94	1.80	2.07	1.79	2.28	1.94	2.38	1.94	2.44	1.93	2.61	2.05	2.72	2.01

Heat Mode

Air flow	outdoor air temp.	indoor air temp				
		16°CDB	18°CDB	20°CDB	22°CDB	24°CDB
		Hi 10.6 (m³/min)	-15°CWB	1.97	1.93	1.88
-10°CWB	2.23		2.19	2.16	2.10	2.06
-5°CWB	2.41		2.38	2.33	2.30	2.27
0°CWB	2.53		2.49	2.45	2.42	2.38
5°CWB	3.22		3.19	3.17	3.10	3.06
6°CWB	3.27		3.24	3.20	3.16	3.12
10°CWB	3.48		3.45	3.42	3.38	3.34
15°CWB	3.79		3.75	3.73	3.69	3.65
20°CWB	4.07	4.04	4.02	3.97	3.94	

Model SRK35ZJ-S

Cool Mode

Air flow	Outdoor air temp.	Indoor air temp													
		21°CDB		23°CDB		26°CDB		27°CDB		28°CDB		31°CDB		33°CDB	
		14°CWB	16°CWB	18°CWB	19°CWB	20°CWB	22°CWB	24°CWB	TC	SHC	TC	SHC	TC	SHC	TC
Hi 10.1 (m³/min)	10	3.94	3.00	4.13	2.95	4.28	3.04	4.35	3.00	4.43	2.97	4.56	3.04	4.68	2.94
	12	3.87	2.97	4.06	2.92	4.22	3.02	4.29	2.98	4.37	2.94	4.51	3.02	4.63	2.93
	14	3.80	2.93	3.99	2.88	4.16	2.99	4.24	2.96	4.31	2.91	4.46	3.00	4.59	2.91
	16	3.72	2.89	3.91	2.85	4.09	2.96	4.18	2.93	4.25	2.89	4.40	2.98	4.54	2.89
	18	3.65	2.85	3.84	2.81	4.03	2.93	4.11	2.90	4.19	2.87	4.35	2.96	4.49	2.88
	20	3.57	2.81	3.76	2.77	3.96	2.90	4.05	2.87	4.13	2.84	4.29	2.94	4.43	2.85
	22	3.49	2.77	3.68	2.73	3.89	2.86	3.98	2.83	4.06	2.80	4.23	2.92	4.38	2.84
	24	3.40	2.72	3.59	2.69	3.81	2.83	3.91	2.81	3.99	2.78	4.17	2.89	4.32	2.81
	26	3.32	2.68	3.51	2.65	3.74	2.80	3.84	2.78	3.92	2.75	4.11	2.86	4.26	2.80
	28	3.23	2.63	3.42	2.61	3.66	2.77	3.77	2.76	3.85	2.72	4.04	2.84	4.20	2.77
	30	3.14	2.59	3.33	2.57	3.58	2.74	3.70	2.72	3.78	2.70	3.98	2.82	4.13	2.75
	32	3.05	2.54	3.24	2.52	3.50	2.70	3.62	2.69	3.70	2.66	3.91	2.79	4.06	2.73
	34	2.95	2.50	3.14	2.48	3.41	2.66	3.54	2.66	3.62	2.63	3.84	2.77	4.00	2.69
	35	2.91	2.48	3.10	2.46	3.37	2.65	3.50	2.64	3.58	2.62	3.80	2.75	3.96	2.68
	36	2.86	2.46	3.05	2.44	3.33	2.63	3.46	2.63	3.54	2.60	3.76	2.72	3.92	2.67
	38	2.76	2.41	2.95	2.40	3.24	2.59	3.38	2.59	3.46	2.57	3.69	2.70	3.85	2.65
	39	2.71	2.39	2.90	2.37	3.20	2.57	3.33	2.58	3.42	2.56	3.65	2.69	3.81	2.64

Heat Mode

Air flow	outdoor air temp.	indoor air temp				
		16°CDB	18°CDB	20°CDB	22°CDB	24°CDB
		Hi 12.8 (m³/min)	-15°CWB	2.46	2.41	2.35
-10°CWB	2.79		2.74	2.70	2.63	2.58
-5°CWB	3.02		2.97	2.91	2.88	2.83
0°CWB	3.16		3.12	3.06	3.02	2.98
5°CWB	4.03		3.98	3.96	3.88	3.83
6°CWB	4.09		4.04	4.00	3.95	3.90
10°CWB	4.35		4.31	4.28	4.22	4.18
15°CWB	4.73		4.69	4.66	4.61	4.56
20°CWB	5.09	5.05	5.02	4.96	4.92	

Reference

1 OUTLINE OF OPERATION CONTROL BY MICROCOMPUTER

1. Operation control function by remote controller

◆ Operation section

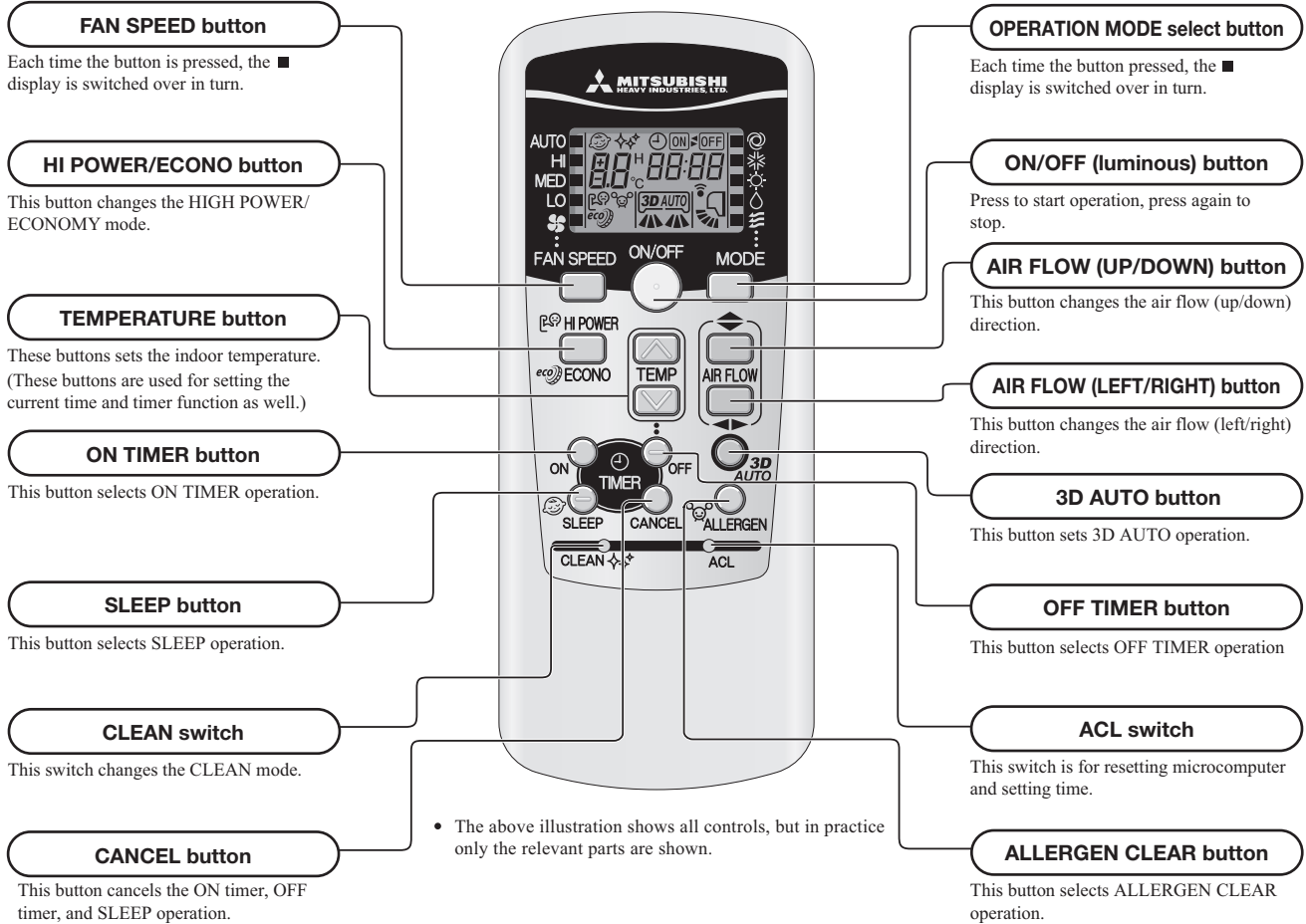

Unit display section

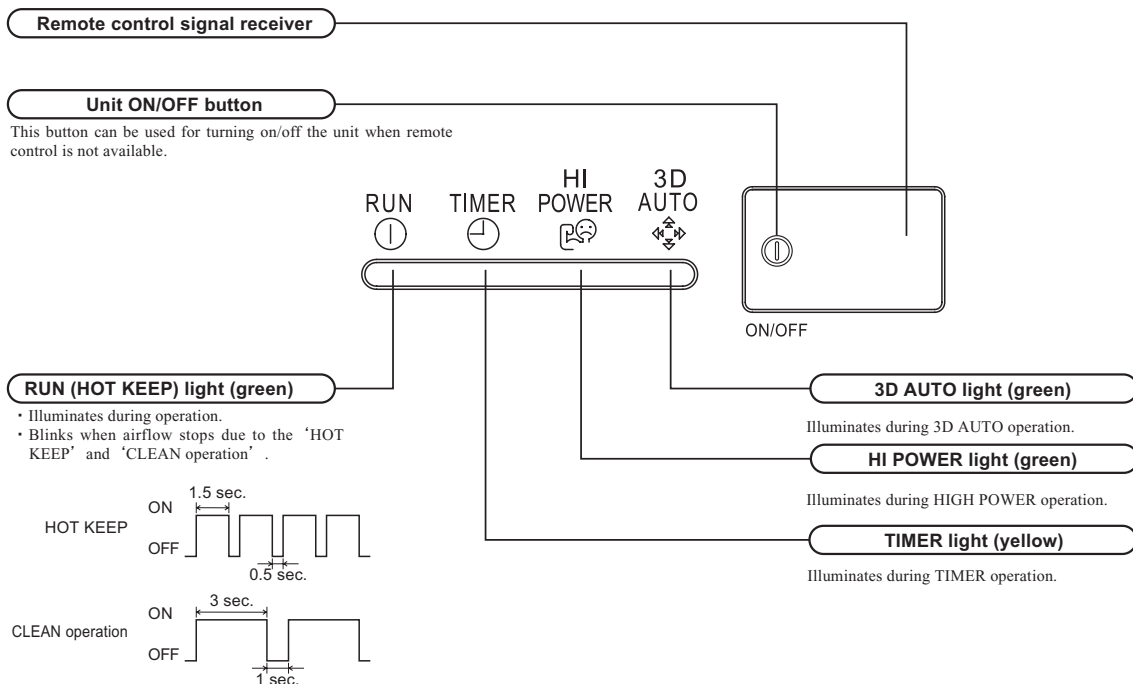

2. Unit ON/OFF button

When the remote controller batteries become weak, or if the remote controller is lost or malfunctioning, this button may be used to turn the unit on and off.

(1) Operation

Push the button once to place the unit in the automatic mode. Push it once more to turn the unit off.

(2) Details of operation

The unit will go into the automatic mode in which it automatically determines, from indoor temperature (as detected by sensor), whether to go into the cooling, thermal dry or heating modes.

Function operation mode	Indoor temperature setting	Fan speed	Flap/Louver	Timer Switch
Cooling	About 24°C	Auto	Auto	Continuous
Thermal dry	About 25°C			
Heating	About 26°C			

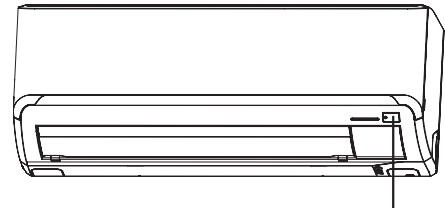

Unit ON/OFF button

3. Auto restart function

(1) Auto restart function records the operational status of the air-conditioner immediately prior to be switched off by a power cut, and then automatically resumes operations after the power has been restored.

(2) The following settings will be cancelled:

- (a) Timer settings
- (b) HIGH POWER operations

- Notes
- (1) Auto restart function is set at on when the air-conditioner is shipped from the factory. Consult with your dealer if this function needs to be switched off.
 - (2) When power failure occurs, the timer setting is cancelled. Once power is resumed, reset the timer.
 - (3) If the jumper wire (JA1) "AUTO RESTART" is cut, auto restart is disabled. (See the diagram at right)

Jumper wire (JA1)

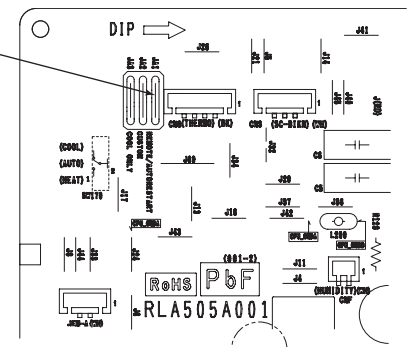

4. Custom cord switching procedure

If two wireless remote controller are installed in one room, in order to prevent wrong operation due to mixed signals, please modify the printed circuit board in the indoor unit's control box and the remote controller using the following procedure. Be sure to modify both boards. If only one board is modified, receiving (and operation) cannot be done.

(1) Modifying the indoor printed circuit board

Take out the printed circuit board from the control box and cut off jumper wire (JA2) using wire cutters.

After cutting of the jumper wire, take measures to prevent contact with the other the lead wires, etc.

(2) Modifying the wireless remote controller

- (a) Remove the battery.
- (b) Cut the jumper wire shown in the figure at right.

Jumper wire (JA2)

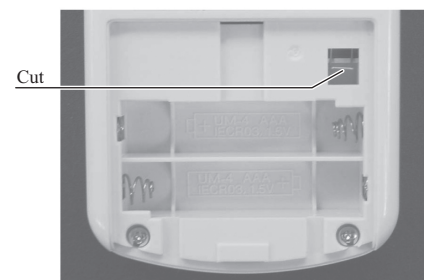
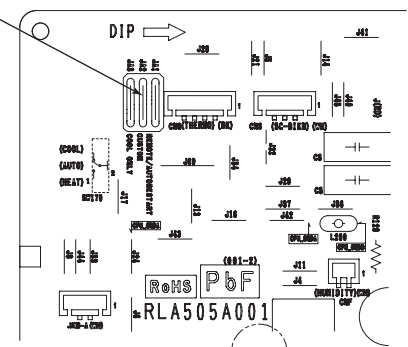

Cut

5. Flap and louver control

Control the flap and louver by AIR FLOW \blacklozenge (UP/DOWN) and $\blacktriangleleft\blacktriangleright$ (LEFT/RIGHT) button on the wireless remote controller.

(1) Flap

Each time when you press the AIR FLOW \blacklozenge (UP/DOWN) button the mode changes as follows.

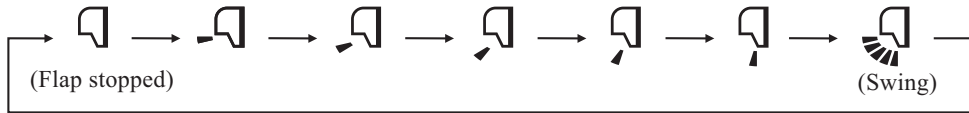

• Angle of Flap from Horizontal

Remote controller display					
COOL , DRY, FAN	Approx. 10°	Approx. 25°	Approx. 40°	Approx. 50°	Approx. 60°
HEAT	Approx. 25°	Approx. 40°	Approx. 50°	Approx. 60°	Approx. 70°

(2) Louver

Each time when you press the AIR FLOW $\blacktriangleleft\blacktriangleright$ (LEFT/RIGHT) button the mode changes as follows.

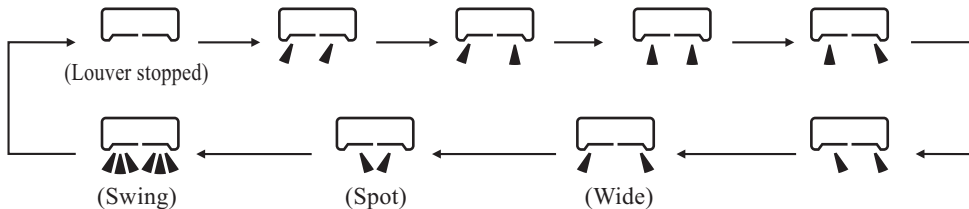

• Angle of Louver

Remote controller display					
Center installation	Left Approx. 50°	Left Approx. 20°	Center	Right Approx. 20°	Right Approx. 50°
Right end installation	Left Approx. 50°	Left Approx. 45°	Left Approx. 30°	Center	Right Approx. 20°
Left end installation	Left Approx. 20°	Center	Right Approx. 30°	Right Approx. 45°	Right Approx. 50°

(3) Swing

(a) Swing flap

Flap moves in upward and downward directions continuously.

\blacklozenge In HEAT operation \blacklozenge In COOL, DRY, FAN operation

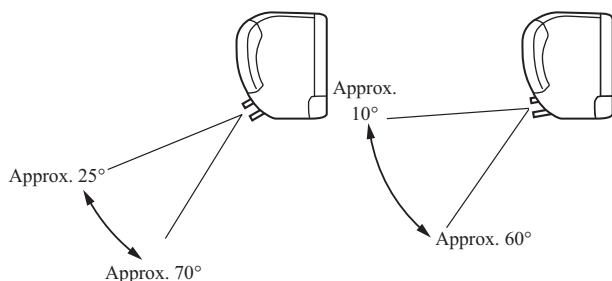

(b) Swing louver

Louver moves in left and right directions continuously.



(4) Memory flap (Flap or Louver stopped)

When you press the AIR FLOW (UP/DOWN or LEFT/RIGHT) button once while the flap or louver is operating, it stops swinging at the position. Since this angle is memorized in the microcomputer, the flap or louver will automatically be set at this angle when the next operation is started.

(5) When not operating

The flap returns to the position of air flow directly below, when operation has stopped.

6. 3D auto operation

Control the flap and louver by 3D AUTO button on the wireless remote controller.

Air flow selection and air flow direction are automatically controlled, allowing the entire indoor to efficiently conditioned.

(1) During Cooling and Heating (Including auto cooling and heating)

(a) Air flow selection is determined according to indoor temperature and setting temperature.

Operation mode	Air flow selection				
	AUTO		HI	MED	LO
At cooling	Indoor temp. – Setting temp. >5°C	Indoor temp. – Setting temp. ≤ 5°C	HI	MED	LO
	HIGH POWER	AUTO			
At heating	Setting temp. – Indoor temp. >5°C	Setting temp. – Indoor temp. ≤ 5°C	HI	MED	LO
	HIGH POWER	AUTO			

(b) Air flow direction is controlled according to the indoor temperature and setting temperature.

1) When 3D auto operation starts

	Cooling	Heating
Flap	Up/down Swing	
Louver	Wide (Fixed)	Center (Fixed)

2) When Indoor temp. – Setting temp. is ≤ 5°C during cooling and when Setting temp. – Indoor temp. is ≤ 5°C during heating, the system switches to the following air flow direction control. After the louver swings left and right symmetrically for 3 cycles, control is switched to the control in 3).

	Cooling	Heating
Flap	Horizontal blowing (Fixed)	Slant forwardl blowing (Fixed)
Louver	Left/right Swing	

3) After the flap swings for 5 cycles, control is switched to the control in 4).

	Cooling	Heating
Flap	Up/down Swing	
Louver	Center (Fixed)	

4) For 5 minutes, the following air flow direction control is carried out.

	Cooling	Heating
Flap	Horizontal blowing (Fixed)	Slant forwardl blowing (Fixed)
Louver	Wide (Fixed)	

5) After 5 minutes have passed, the air flow direction is determined according to the indoor temperature and setting temperature.

Operation mode	Air flow direction control		
At cooling	Indoor temp. – Setting temp. ≤ 2°C	2°C < Indoor temp. – Setting temp. ≤ 5°C	Indoor temp. – Setting temp. > 5°C
	The control in 4) continues.	Control returns to the control in 2).	Control returns to the control in 1).
At heating	Setting temp. – Indoor temp. ≤ 2°C	2°C < Setting temp. – Indoor temp. ≤ 5°C	Setting temp. – Indoor temp. > 5°C
	The control in 4) continues.	Control returns to the control in 2).	Control returns to the control in 1).

(2) During DRY Operation (including auto DRY operation)

Air flow selection	According to DRY operation.
Flap	Horizontal blowing (Fixed)
Louver	Wide (Fixed)

7. Timer operation

(1) Comfortable timer setting (ON timer)

If the timer is set at ON when the operation select switch is set at the cooling or heating, or the cooling or heating in auto mode operation is selected, the comfortable timer starts and determines the starting time of next operation based on the initial value of 15 minutes and the relationship between the indoor temperature at the setting time (temperature of room temperature sensor) and the setting temperature.

(2) Sleep timer operation

Pressing the SLEEP button causes the temperature to be controlled with respect to the set temperature.

(3) OFF timer operation

The Off timer can be set at a specific time (in 10-minute units) within a 24-hour period.

8. Installation location setting

When the indoor unit is installed at the end of a room, control the air flow direction so that it is not toward the side walls. If you set the remote controller installation position, keep it so that the air flow is within the range shown in the following figure.

(1) Setting

(a) If the air conditioning unit is running, press the ON/OFF button to stop.

The installation location setting cannot be made while the unit is running.

(b) Press the AIR FLOW \updownarrow (UP/DOWN) button and the AIR FLOW $\leftarrow\rightarrow$ (LEFT/RIGHT) button together for 5 seconds or more.

The installation location display illuminates.

(c) Setting the air-conditioning installation location.

Press the AIR FLOW $\leftarrow\rightarrow$ (LEFT/RIGHT) button and adjust to the desired location.

Each time the AIR FLOW $\leftarrow\rightarrow$ (LEFT/RIGHT) button is pressed, the indicator is switched in the order of:

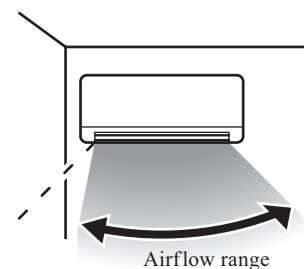
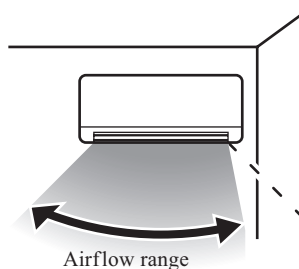
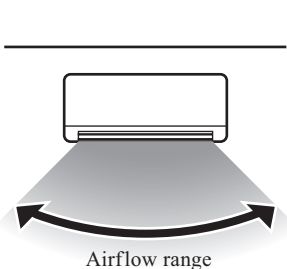

(d) Press the ON/OFF button.

The air-conditioner's installation location is set.

Press within 60 seconds of setting the installation location (while the installation location setting display illuminates).

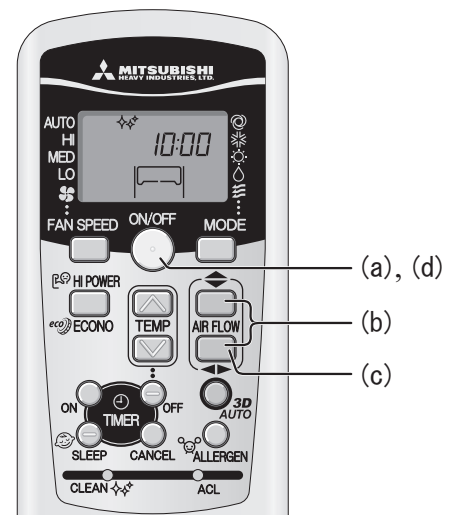

9. Outline of heating operation

(1) Operation of major functional components in heating mode

	Heating		
	Thermostat ON	Thermostat OFF	Failure
Compressor	ON	OFF	OFF
Indoor fan motor	ON	ON(HOT KEEP)	OFF
Outdoor fan motor	ON	OFF (few minutes ON)	OFF
4-way valve	ON	ON	OFF (3 minutes ON)

(2) Details of control at each operation mode (pattern)

(a) Fuzzy operation

Deviation between the indoor temperature setting correction temperature and the return air temperature is calculated in accordance with the fuzzy rule, and used for control of the air capacity and the compressor speed.

Fan speed	Model	SRK20ZJ-S	SRK25ZJ-S	SRK35ZJ-S
	Auto		30~115rps	30~115rps
HI		30~115rps	30~115rps	30~115rps
MED		30~66rps	30~72rps	30~76rps
LO		30~40rps	30~42rps	30~46rps

When the defrosting, protection device, etc. is actuated, operation is performed in the corresponding mode.

(b) Hot keep operation

If the hot keep operation is selected during the heating operation, the indoor blower is controlled based on the temperature of the indoor heat exchanger (Th2) to prevent blowing of cool wind.

(3) Defrosting operation

(a) Starting conditions (Defrosting operation can be started only when all of the following conditions are met.)

- 1) After start of heating operation
When it elapsed 45 minutes. (Accumulated compressor operation time)
- 2) After end of defrosting operation
When it elapsed 45 minutes. (Accumulated compressor operation time)
- 3) Outdoor heat exchanger sensor (TH1) temperature
When the temperature has been below -5°C for 3 minutes continuously.
- 4) The difference between the outdoor air sensor temperature and the outdoor heat exchanger sensor temperature
 - The outdoor air temperature $\geq 0^{\circ}\text{C} : 7^{\circ}\text{C}$ or higher
 - $-15^{\circ}\text{C} \leq$ The outdoor air temperature $< 0^{\circ}\text{C} : 4/15 \times$ The outdoor air temperature $+ 7^{\circ}\text{C}$ or higher
 - The outdoor air temperature $< -15^{\circ}\text{C} : -5^{\circ}\text{C}$ or higher
- 5) During continuous compressor operation

In addition, when the speed command from the indoor controller of the indoor unit during heating operation has counted 0 rps 10 times or more and all conditions of 1), 2), 3) and 5) above and the outdoor air temperature is 3°C or less are satisfied (note that when the temperature for outdoor heat exchanger sensor (TH1) is -5°C or less: 62 rps or more, -4°C or less: less than 62 rps), defrost operation is started.

(b) Ending conditions (Operation returns to the heating cycle when either one of the following is met.)

- 1) Outdoor heat exchanger sensor (TH1) temperature: 13°C or higher
- 2) Continued operation time of defrosting → For more than 15 min.

10. Outline of cooling operation

(1) Operation of major functional components in Cooling mode

	Cooling		
	Thermostat ON	Thermostat OFF	Failure
Compressor	ON	OFF	OFF
Indoor fan motor	ON	ON	OFF
Outdoor fan motor	ON	OFF (few minutes ON)	OFF (few minutes ON)
4-way valve	OFF	OFF	OFF

(2) Detail of control in each mode (Pattern)

(a) Fuzzy operation

During the fuzzy operation, the air flow and the compressor speed are controlled by calculating the difference between the indoor temperature setting correction temperature and the return air temperature.

Model	SRK20ZJ-S	SRK25ZJ-S	SRK35ZJ-S
Fan speed			
Auto	20~66rps	20~74rps	20~98rps
HI	20~66rps	20~74rps	20~98rps
MED	20~44rps	20~55rps	20~58rps
LO	20~30rps	20~34rps	20~38rps

11. Outline of automatic operation

(1) Determination of operation mode

The unit checks the indoor air temperature and setting temperature and the outdoor air temperature, determines the operation mode, and then begins in the automatic operation.

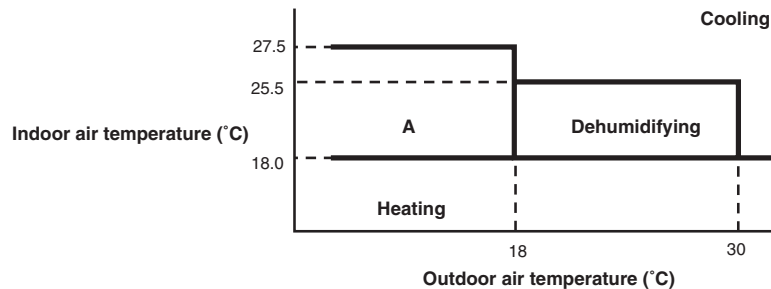

(2) The unit checks the temperature every hour after the start of operation and, if the result of check is not same as the previous operation mode, changes the operation mode.

- (a) If the setting temperature is changed with the remote controller, the operation mode is judged immediately.
- (b) When both the indoor and the outdoor air temperatures are in the range “A”, cooling or heating is switched depending on the difference between the setting temperature and the indoor air temperature.
- (c) When the operation mode has been judged following the change of setting temperature with the remote controller, the hourly judgment of operation mode is cancelled.

(3) When the unit is started again within one hour after the stop of automatic operation or when the automatic operation is selected during heating, cooling or dehumidifying operation, the unit is operated in the previous operation mode.

(4) Setting temperature can be adjusted within the following range. There is the relationship as shown below between the signals of the wireless remote controller and the setting temperature.

		Signals of wireless remote controller (Display)												
		-6	-5	-4	-3	-2	-1	±0	+1	+2	+3	+4	+5	+6
Setting temperature	Cooling	18	19	20	21	22	23	24	25	26	27	28	29	30
	Dehumidifying	19	20	21	22	23	24	25	26	27	28	29	30	31
	Heating	20	21	22	23	24	25	26	27	28	29	30	31	32

Unit : °C

12. Protective control function

(1) Frost prevention control (During cooling or dehumidifying)

(a) Operating conditions

- 1) Indoor heat exchanger temperature (Th2) is lower than 5°C.
- 2) 5 minutes after reaching the compressor command speed except 0 rps.

(b) Detail of anti-frost operation

Indoor heat exchanger temperature	5°C or lower	2.5°C or lower
Item		
Lower limit of compressor command speed	22 rps	0 rps
Indoor fan	Depends on operation mode	Protects the fan tap just before frost prevention control
Outdoor fan	Depends on command speed	Depends on stop mode
4-way valve	OFF	

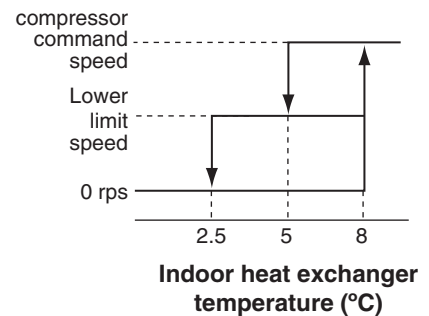

- Notes
- (1) When the indoor heat exchanger temperature is in the range of 2.5~5°C, the speed is reduced by 4 rps at each 20 seconds.
 - (2) When the temperature is lower than 2.5°C, the compressor is stopped.
 - (3) When the indoor heat exchanger temperature is in the range of 5~8°C, the compressor command speed is been maintained.

(c) Reset conditions: When either of the following condition is satisfied.

- 1) The indoor heat exchanger temperature (Th2) is 8°C or higher.
- 2) The compressor command speed is 0 rps.

(2) Cooling overload protective control

(a) **Operating conditions:** When the outdoor air temperature (TH2) has become continuously for 30 seconds at 41°C or more, or 47°C or more with the compressor running, the lower limit speed of compressor is brought up.

Model	SRK20~35ZJ-S	
Item		
Outdoor air temperature	41°C or more	47°C or more
Lower limit speed	30 rps	40 rps

(b) Detail of operation

- 1) The outdoor fan is stepped up by 3 speed step. (Upper limit 7th speed.)
- 2) The lower limit of compressor command speed is set to 30 or 40 rps and even if the calculated result becomes lower than that after fuzzy calculation, the speed is kept to 30 or 40 rps. However, when the thermo becomes OFF, the speed is reduced to 0 rps.

(c) Reset conditions: When either of the following condition is satisfied.

- 1) The outdoor air temperature is lower than 40°C or 46°C.
- 2) The compressor command speed is 0 rps.

(3) Cooling high pressure control

(a) **Purpose:** Prevents anomalous high pressure operation during cooling.

(b) **Detector:** Outdoor heat exchanger sensor (TH1)

(c) **Detail of operation:**

(Example) Fuzzy

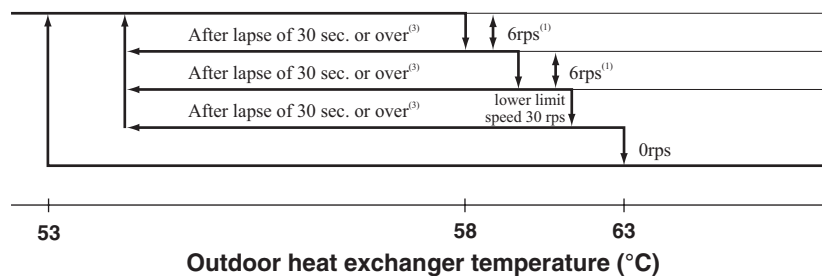

- Notes
- (1) When the outdoor heat exchanger temperature is in the range of 58~63°C, the speed is reduced by 6 rps at each 30 seconds.
 - (2) When the temperature is 63°C or higher, the compressor is stopped.
 - (3) When the outdoor heat exchanger temperature is in the range of 53~58°C, if the compressor command speed is been maintained and the operation has continued for more than 30 seconds at the same speed, it returns to the normal cooling operation.

(4) Cooling low outdoor air temperature protective control

(a) Operating conditions: When the outdoor air temperature (TH2) is 22°C or lower continues for 20 seconds while the compressor command speed is other than 0 rps.

(b) Detail of operation:

- 1) The lower limit of the compressor command speed is set to 50 <44> (30) rps and even if the speed becomes lower than 50 <44> (30) rps, the speed is kept to 50 (44) (30) rps. However, when the thermo becomes OFF, the speed is reduced to 0 rps.
- 2) The upper limit of the compressor command speed is set to 50 <50> (60) rps and even if the calculated result becomes higher than that after fuzzy calculation, the speed is kept to 50 <50> (60) rps.

Notes (1) Values in < > are for outdoor air temperature is 0°C or 3°C
 (2) Values in () are for outdoor air temperature is 22°C or 25°C

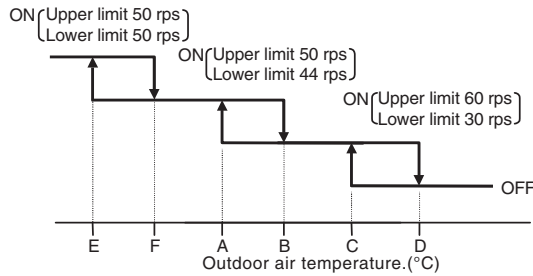

● Values of A, B, C, D, E, F

	Outdoor air temperature. (°C)					
	E	F	A	B	C	D
First time	-8	-5	0	3	22	25
Since the seconds times	-2	1	5	8	25	28

(c) Reset conditions: When either of the following condition is satisfied

- 1) The outdoor air temperature (TH2) is D °C or higher.
- 2) The compressor command speed is 0 rps.

(5) Heating high pressure control

(a) Purpose: Prevents anomalous high pressure operation during heating.

(b) Detector: Indoor heat exchanger sensor (Th2)

(c) Detail of operation:

(Example) Fuzzy

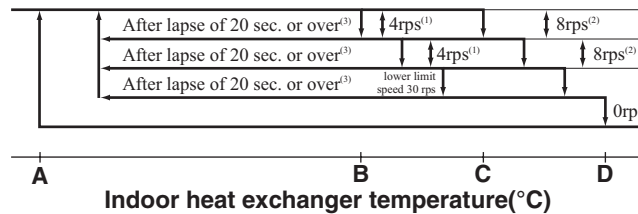

Notes (1) When the indoor heat exchanger temperature is in the range of B~C °C, the speed is reduced by 4 rps at each 20 seconds.
 (2) When the indoor heat exchanger temperature is in the range of C~D °C, the speed is reduced by 8 rps at each 20 seconds. When the temperature is D °C or higher continues for 1 minute, the compressor is stopped.
 (3) When the indoor heat exchanger temperature is in the range of A~B °C, if the compressor command speed is been maintained and the operation has continued for more than 20 seconds at the same speed, it returns to the normal heating operation.
 (4) Indoor blower retains the fan tap when it enters in the high pressure control. Outdoor blower is operated in accordance with the speed.

● **Temperature list**

Unit : °C

	A	B	C	D
RPSmin < 50	48	53	55	58
50 ≤ RPSmin < 91	48.5	56	58	61
91 ≤ RPSmin < 97	48.5	56 ~ 52.5	58	61
97 ≤ RPSmin < 100	48.5	52.5 ~ 50.8	58 ~ 56.2	61
100 ≤ RPSmin < 115	48.5 ~ 40.1	50.8 ~ 42	56.2 ~ 47.3	61
115 ≤ RPSmin	40.1	42	47.3	61

Note (1) RPSmin: The lower one between the outdoor speed and the compressor command speed

(6) Heating overload protective control**(a) Indoor unit side**

- 1) **Operating conditions** : When the outdoor air temperature (TH2) is 17°C or higher continues for 30 seconds while the compressor command speed other than 0 rps.
- 2) **Detail of operation** : The indoor fan is stepped up by 1 speed step. (Upper limit 8th speed)
- 3) **Reset conditions** : The outdoor air temperature (TH2) is lower than 16°C.

(b) Outdoor unit side

- 1) **Operating conditions** : When the outdoor air temperature (TH2) is 22°C or higher continues for 30 seconds while the compressor command speed other than 0 rps.
- 2) **Detail of operation**
 - a) Taking the upper limit of compressor command speed range at 60 rps, if the output speed obtained with the fuzzy calculation exceeds the upper limit, the upper limit value is maintained.
 - b) The lower limit of compressor command speed is set to 40 rps and even if the calculated result becomes lower than that after fuzzy calculation, the speed is kept to 40 rps. However, when the thermo becomes OFF, the speed is reduced to 0 rps.
 - c) Inching prevention control is activated and inching prevention control is carried out with the minimum speed set at 40 rps.
 - d) The outdoor fan is set on 2nd speed.
- 3) **Reset conditions**: The outdoor air temperature (TH2) is lower than 21°C.

(7) Heating low outdoor temperature protective control

- (a) **Operating conditions**: When the outdoor air temperature (TH2) is lower than -2°C or higher continues for 30 seconds while the compressor command speed is other than 0 rps.
- (b) **Detail of operation**: The lower limit compressor command speed is change as shown in the figure below.

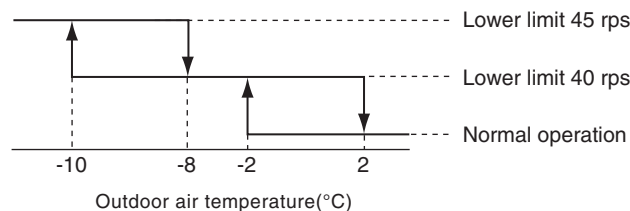

- (c) **Reset conditions**: When either of the following condition is satisfied.
 - 1) The outdoor air temperature (TH2) becomes -2°C.
 - 2) The compressor command speed is 0 rps.

(8) Compressor overheat protection

(a) Purpose: It is designed to prevent deterioration of oil, burnout of motor coil and other trouble resulting from the compressor overheat.

(b) Detail of operation

1) Speeds are controlled with temperature detected by the sensor (TH3) mounted on the discharge pipe.

(Example) Fuzzy

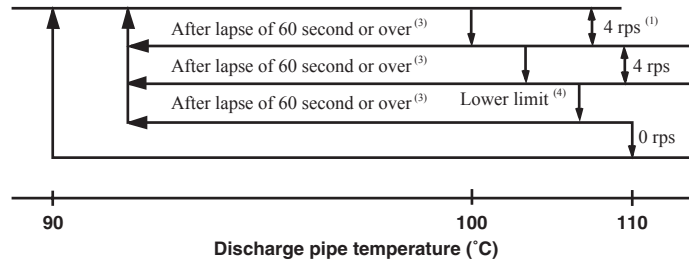

- Notes (1) When the discharge pipe temperature is in the range of 100~110°C, the speed is reduced by 4 rps.
 (2) When the discharge pipe temperature is raised and continues operation for 20 seconds without changing, then the speed is reduced again by 4 rps.
 (3) If the discharge pipe temperature is in the range of 90~100°C even when the compressor command speed is maintained for 60 second when the temperature is in the range of 90~100°C, the speed is raised by 1 rps and kept at that speed for 60 second. This process is repeated until the command speed is reached.
 (4) Lower limit speed

Model	Item	
	Cooling	Heating
Lower Limit Speed	20 rps	30 rps

2) If the temperature of 110°C is detected by the sensor on the discharge pipe, then the compressor will stop immediately. When the discharge pipe temperature drops and the time delay of 3 minutes is over, the unit starts again within 1 hour but there is no start at the third time.

(9) Current safe

(a) Purpose: Current is controlled not to exceed the upper limit of the setting operation current.

(b) Detail of operation: Input current to the converter is monitored with the current sensor fixed on the printed circuit board of the outdoor unit and, if the operation current value reaches the limiting current value, the compressor command speed is reduced.

If the mechanism is actuated when the compressor command speed is less than 30 rps, the compressor is stopped immediately. Operation starts again after a delay time of 3 minutes.

(10) Current cut

(a) Purpose: Inverter is protected from overcurrent.

(b) Detail of operation: Output current from the inverter is monitored with a shunt resistor and, if the current exceeds the setting value, the compressor is stopped immediately. Operation starts again after a delay time of 3 minutes.

(11) Outdoor unit failure

This is a function for determining when there is trouble with the outdoor unit during air conditioning.

The compressor is stopped if any one of the following in item (a), (b) is satisfied. Once the unit is stopped by this function, it is not restarted.

- (a) When the input current is measured at 1 A or less for 3 continuous minutes or more.
- (b) If the outdoor unit sends a 0 rps signal to the indoor unit 3 times or more within 20 minutes of the power being turned on.

(12) Indoor fan motor protection

When the air conditioner is operating and the indoor fan motor is turned ON, if the indoor fan motor has operated at 300 rpm or under for more than 30 seconds, the unit enters first in the stop mode and then stops the entire system.

(13) Serial signal transmission error protection

- (a) **Purpose:** Prevents malfunction resulting from error on the indoor ↔ outdoor signals.
- (b) **Detail of operation:** If the compressor is operating and a serial signal cannot be received from the indoor control with outdoor control having serial signals continues for 7 minute and 35 seconds, the compressor is stopped.
After the compressor has been stopped, it will be restarted after the compressor start delay if a serial signal can be received again from the indoor control.

(14) Rotor lock

If the motor for the compressor does not turn after it has been started, it is determined that a compressor lock has occurred and the compressor is stopped.

(15) Outdoor fan motor protection

If the outdoor fan motor has operated at 75 rpm or under for more than 30 seconds, the compressor and fan motor are stopped.

(16) Outdoor fan control at low outdoor temperature

◆ **Cooling**

- (a) **Operating conditions:** When the outdoor air temperature (TH2) is 22°C or lower continues for 30 seconds while the compressor command speed is other than 0 rps.
- (b) **Detail of operation:** After the outdoor fan operates at A speed for 60 seconds; the corresponding outdoor heat exchanger temperature shall implement the following controls.

● Value of A

	Outdoor fan
Outdoor temperature > 10°C	2nd speed
Outdoor temperature ≤ 10°C	1st speed

- 1) Outdoor heat exchanger temperature (TH1) ≤ 21°C
After the outdoor fan speed drops (down) to 1 speed for 60 seconds; if the outdoor heat exchanger temperature is lower than 21°C, gradually reduce the outdoor fan speed by 1 speed. (Lower limit 1st speed)
- 2) 21°C < Outdoor heat exchanger temperature (TH1) ≤ 38°C
After the outdoor fan speed maintains at A speed for 20 seconds; if the outdoor heat exchanger temperature is 21°C~38°C, maintain outdoor fan speed.
- 3) Outdoor heat exchanger temperature (TH1) > 38°C
After the outdoor fan speed rises (up) to 1 speed for 60 seconds; if the outdoor heat exchanger temperature is higher than 38°C, gradually increase outdoor fan speed by 1 speed. (Upper limit 3rd speed)
- (c) **Reset conditions:** When either of the following conditions is satisfied
 - 1) The outdoor air temperature (TH2) is 25°C or higher.
 - 2) The compressor command speed is 0 rps.

◆ **Heating**

- (a) **Operating conditions:** When the outdoor air temperature (TH2) is 4°C or lower continues for 30 seconds while the compressor command speed is other than 0 rps.
- (b) **Detail of operation:** The outdoor fan is stepped up by 2 speed step at each 20 seconds. (Upper limit 8th speed)
- (c) **Reset conditions:** When either of the following conditions is satisfied
 - 1) The outdoor air temperature (TH2) is 6°C or higher.
 - 2) The compressor command speed is 0 rps.

Reference

2 TROUBLESHOOTING PROCEDURES FOR ELECTRICAL EQUIPMENT

(1) Cautions

- (a) If you are disassembling and checking an air conditioner, be sure to turn off the power before beginning. When working on indoor units, let the unit sit for about 1 minute after turning off the power before you begin work. When working on an outdoor unit, there may be an electrical charge applied to the main circuit (electrolytic condenser), so begin work only after discharging this electrical charge (to DC 10 V or lower).
- (b) When taking out printed circuit boards, be sure to do so without exerting force on the circuit boards or package components.
- (c) When disconnecting and connecting connectors, take hold of the connector housing and do not pull on the lead wires.

(2) Items to check before troubleshooting

- (a) Have you thoroughly investigated the details of the trouble which the customer is complaining about?
- (b) Is the air conditioner running? Is it displaying any self-diagnosis information?
- (c) Is a power supply with the correct voltage connected?
- (d) Are the control lines connecting the indoor and outdoor units wired correctly and connected securely?
- (e) Is the outdoor unit's service valve open?

(3) Troubleshooting procedure (If the air conditioner does not run at all)

If the air conditioner does not run at all, diagnose the trouble using the following troubleshooting procedure. If the air conditioner is running but breaks down, proceed to troubleshooting step (4).

Important When all the following conditions are met, we say that the air conditioner will not run at all.

- (a) The RUN light does not light up.
- (b) The flaps do not open.
- (c) The indoor unit fan motors do not run.
- (d) The self-diagnosis display does not function.

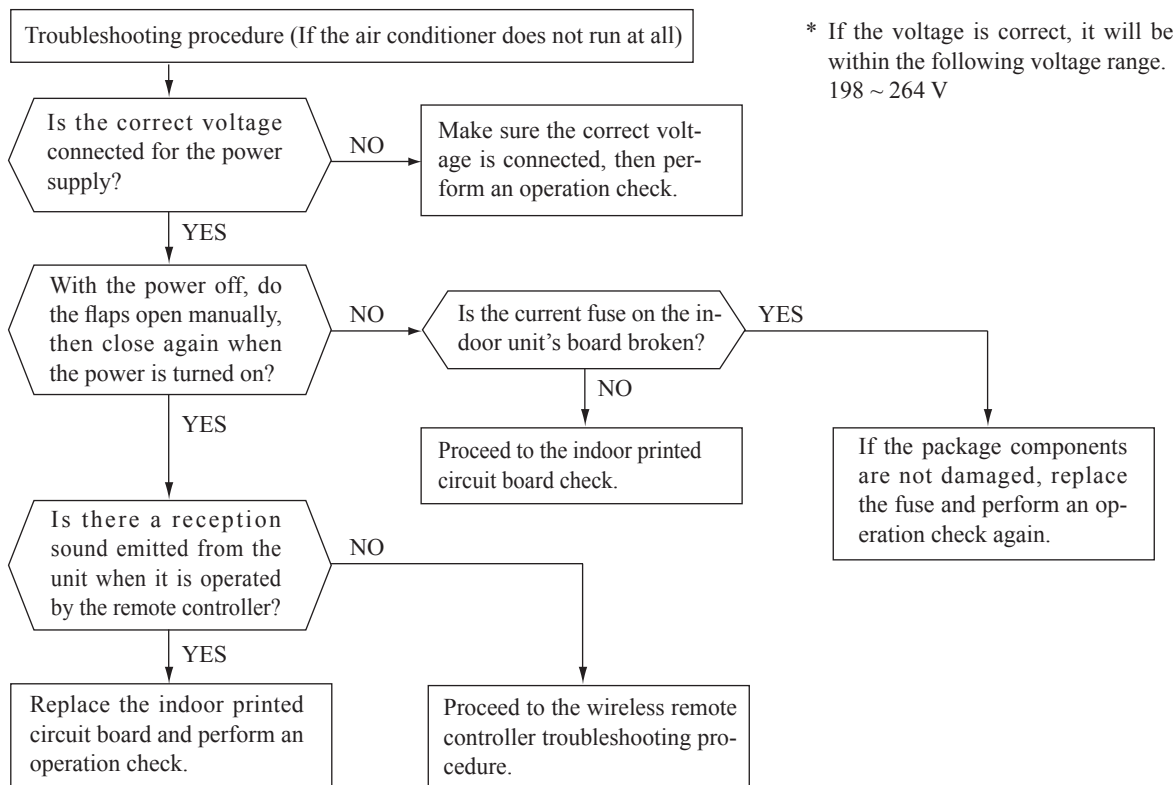

(4) Troubleshooting procedure (If the air conditioner runs)

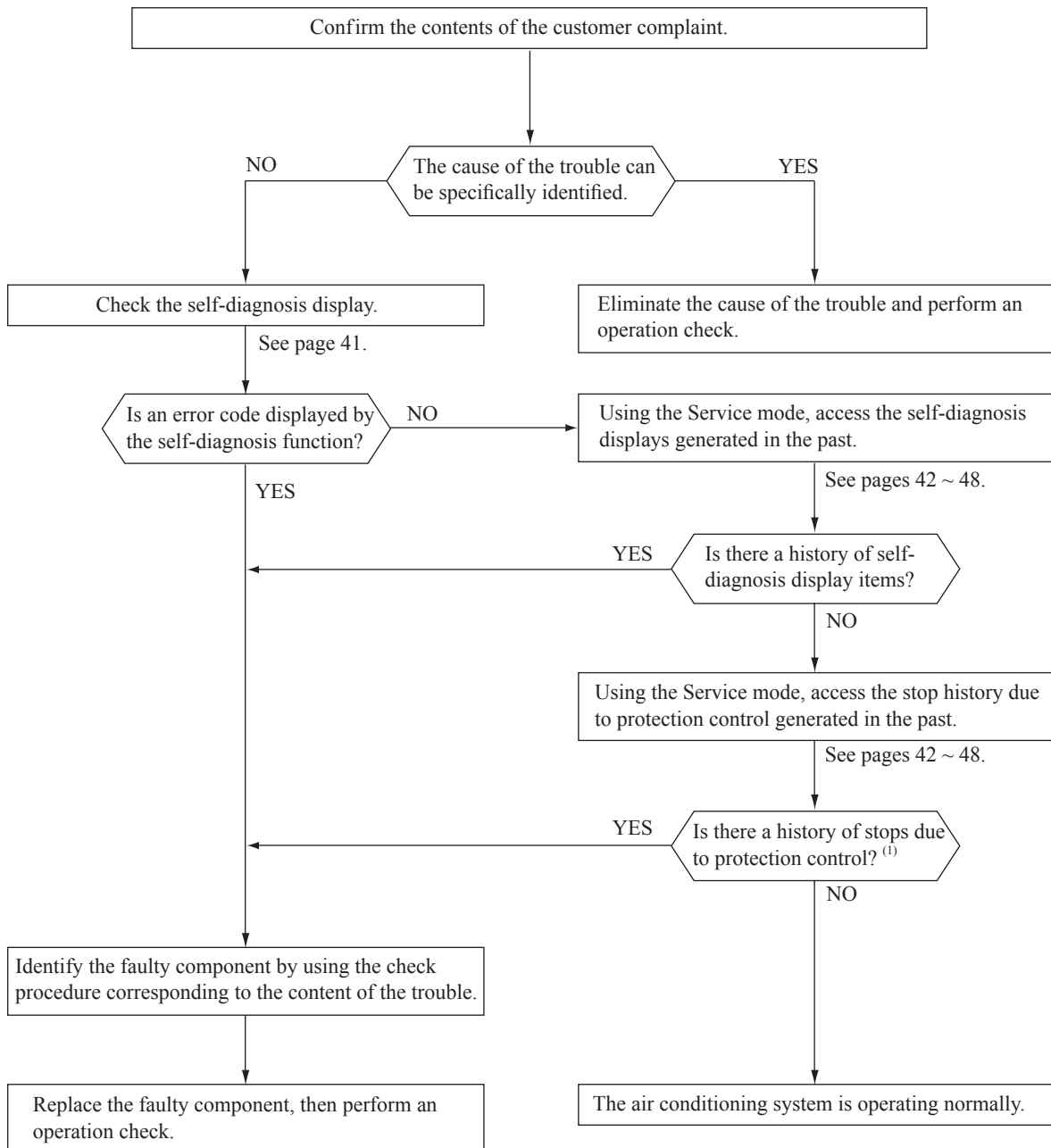

Note (1) Even in cases where only intermittent stop data are generated, the air conditioning system is normal. However, if the same protective operation recurs repeatedly (3 or more times), it will lead to customer complaints. Judge the conditions in comparison with the contents of the complaints.

(5) Self-diagnosis table

When this air conditioner performs an emergency stop, the reason why the emergency stop occurred is displayed by the flashing of display lights. If the air conditioner is operated using the remote controller 3 minutes or more after the emergency stop, the trouble display stops and the air conditioner resumes operation. ⁽¹⁾

Indoor unit display panel		Wired remote controller display	Description of trouble	Cause	Display (flashing) condition
RUN light	TIMER light				
1 time flash	ON	—	Heat exchanger sensor 1 error	<ul style="list-style-type: none"> Broken heat exchanger sensor 1 wire, poor connector connection Indoor PCB is faulty 	When a heat exchanger sensor 1 wire disconnection is detected while operation is stopped. (If a temperature of -28°C or lower is detected for 15 seconds, it is judged that the wire is disconnected.) (Not displayed during operation.)
2 time flash	ON	—	Room temperature sensor error	<ul style="list-style-type: none"> Broken room temperature sensor wire, poor connector connection Indoor PCB is faulty 	When a room temperature sensor wire disconnection is detected while operation is stopped. (If a temperature of -28°C or lower is detected for 15 seconds, it is judged that the wire is disconnected.) (Not displayed during operation.)
3 time flash	ON	—	Heat exchanger sensor 2 error	<ul style="list-style-type: none"> Broken heat exchanger sensor 2 wire, poor connector connection Indoor PCB is faulty 	When a heat exchanger sensor 2 wire disconnection is detected while operation is stopped. (If a temperature of -28°C or lower is detected for 15 seconds, it is judged that the wire is disconnected.) (Not displayed during operation.)
6 time flash	ON	E 16	Indoor fan motor error	<ul style="list-style-type: none"> Defective fan motor, poor connector connection 	When conditions for turning the indoor unit's fan motor on exist during air conditioner operation, an indoor unit fan motor speed of 300 rpm or lower is measured for 30 seconds or longer. (The air conditioner stops.)
Keeps flashing	1 time flash	E 38	Outdoor air temperature sensor error	<ul style="list-style-type: none"> Broken outdoor air temp. sensor wire, poor connector connection Outdoor PCB is faulty 	-55°C or lower is detected for 5 seconds continuously 3 times within 40 minutes after initial detection of this anomalous temperature. Or -55°C or higher is detected for 5 seconds continuously within 20 seconds after compressor ON. (The compressor is stopped.)
Keeps flashing	2 time flash	E 37	Outdoor heat exchanger sensor error	<ul style="list-style-type: none"> Broken heat exchanger sensor wire, poor connector connection Outdoor PCB is faulty 	-55°C or lower is detected for 5 seconds continuously 3 times within 40 minutes after initial detection of this anomalous temperature. Or -55°C or higher is detected for 5 seconds continuously within 20 seconds after compressor ON. (The compressor is stopped.)
Keeps flashing	4 time flash	E 39	Discharge pipe sensor error	<ul style="list-style-type: none"> Broken discharge pipe sensor wire, poor connector connection Outdoor PCB is faulty 	-25°C or lower is detected for 5 seconds continuously 3 times within 40 minutes after initial detection of this anomalous temperature. (The compressor is stopped.)
ON	1 time flash	E 42	Current cut	<ul style="list-style-type: none"> Compressor locking, open phase on compressor output, short circuit on power transistor, service valve is closed 	The compressor output current exceeds the set value during compressor start. (The air conditioner stops.)
ON	2 time flash	E 59	Trouble of outdoor unit	<ul style="list-style-type: none"> Broken compressor wire Compressor blockage 	When there is an emergency stop caused by trouble in the outdoor unit, or the input current value is found to be lower than the set value. (The air conditioner stops.)
ON	3 time flash	E 58	Current safe stop	<ul style="list-style-type: none"> Overload operation Overcharge Compressor locking 	When the compressor command speed is lower than the set value and the current safe has operated. (the compressor stops)
ON	4 time flash	E 51	Power transistor error	<ul style="list-style-type: none"> Broken power transistor 	When the power transistor is judged breakdown while compressor starts. (The compressor is stopped.)
ON	5 time flash	E 36	Over heat of compressor	<ul style="list-style-type: none"> Gas shortage, defective discharge pipe sensor, service valve is closed 	When the value of the discharge pipe sensor exceeds the set value. (The air conditioner stops.)
ON	6 time flash	E 5	Error of signal transmission	<ul style="list-style-type: none"> Defective power supply, Broken signal wire, defective indoor/outdoor PCB 	When there is no signal between the indoor PCB and outdoor PCB for 10 seconds or longer (when the power is turned on), or when there is no signal for 7 minute 35 seconds or longer (during operation)(the compressor is stopped).
ON	7 time flash	E 48	Outdoor fan motor error	<ul style="list-style-type: none"> Defective fan motor, poor connector connection 	When the outdoor unit's fan motor speed continues for 30 seconds or longer at 75 rpm or lower. (3 times) (The air conditioner stops.)
ON	Keeps flashing	E 35	Cooling high pressure protecton	<ul style="list-style-type: none"> Overload operation, overcharge Broken outdoor heat exchange sensor wire Service valve is closed 	When the value of the outdoor heat exchanger sensor exceeds the set value.
2 time flash	2 time flash	E 60	Rotor lock	<ul style="list-style-type: none"> Defective compressor Open phase on compressor Defective outdoor PCB 	If the compressor motor's magnetic pole positions cannot be correctly detected when the compressor starts. (The air conditioner stops.)
5 time flash	ON	E 47	Active filter voltage error	<ul style="list-style-type: none"> Defective active filter 	When the wrong voltage connected for the power supply. When the outdoor PCB is faulty.
7 time flash	ON	E 57	Refrigeration cycle system protective control	<ul style="list-style-type: none"> Service valve is closed. Refrigerant is insufficient 	When refrigeration cycle system protective control operates.
—	—	E 1	Error of wired remote controller wiring	<ul style="list-style-type: none"> Broken wired remote controller wire, defective indoor PCB 	The wired remote controller wire Y is open. The wired remote controller wires X and Y are reversely connected. Noise is penetrating the wired remote controller lines. The wired remote controller or indoor PCB is faulty. (The communications circuit is faulty.)

Notes (1)The air conditioner cannot be restarted using the remote controller for 3 minutes after operation stops.

(2)The wired remote controller is optional parts.

(6) Service mode (Trouble mode access function)

This air conditioner is capable of recording error displays and protective stops (service data) which have occurred in the past. If self-diagnosis displays cannot be confirmed, it is possible to get a grasp of the conditions at the time trouble occurred by checking these service data.

(a) Explanation of terms

Term	Explanation
Service mode	The service mode is the mode where service data are displayed by flashing of the display lights when the operations in item (b) below are performed with the indoor controller.
Service data	These are the contents of error displays and protective stops which occurred in the past in the air conditioner system. Error display contents and protective stop data from past anomalous operations of the air conditioner system are saved in the indoor unit controller's non-volatile memory (memory which is not erased when the power goes off). There are two types of data, self-diagnosis data and stop data, described below.
Self-diagnosis data	These are the data which display the reason why a stop occurred when an error display(self-diagnosis display) occurred in an indoor unit. Data are recorded for up to 5 previous occurrences. Data which are older than the 5th previous occurrence are erased. In addition, data on the temperature of each sensor (room temperature, indoor heat exchanger, outdoor heat exchanger, outdoor air temperature, discharge pipe), remote controller information (operation switching, fan speed switching) are recorded when trouble occurs, so more detailed information can be checked.
Stop data	These are the data which display the reason by a stop occurred when the air conditioning system performed protective stops, etc. in the past. Even if stop data alone are generated, the system restarts automatically. (After executing the stop mode while the display is normal, the system restarts automatically.) Data for up to 10 previous occasions are stored. Data older than the 10th previous occasion are erased. (Important) In cases where transient stop data only are generated, the air conditioner system may still be normal. However, if the same protective stop occurs frequently (3 or more times), it could lead to customer complaints.

(b) Service mode display procedure

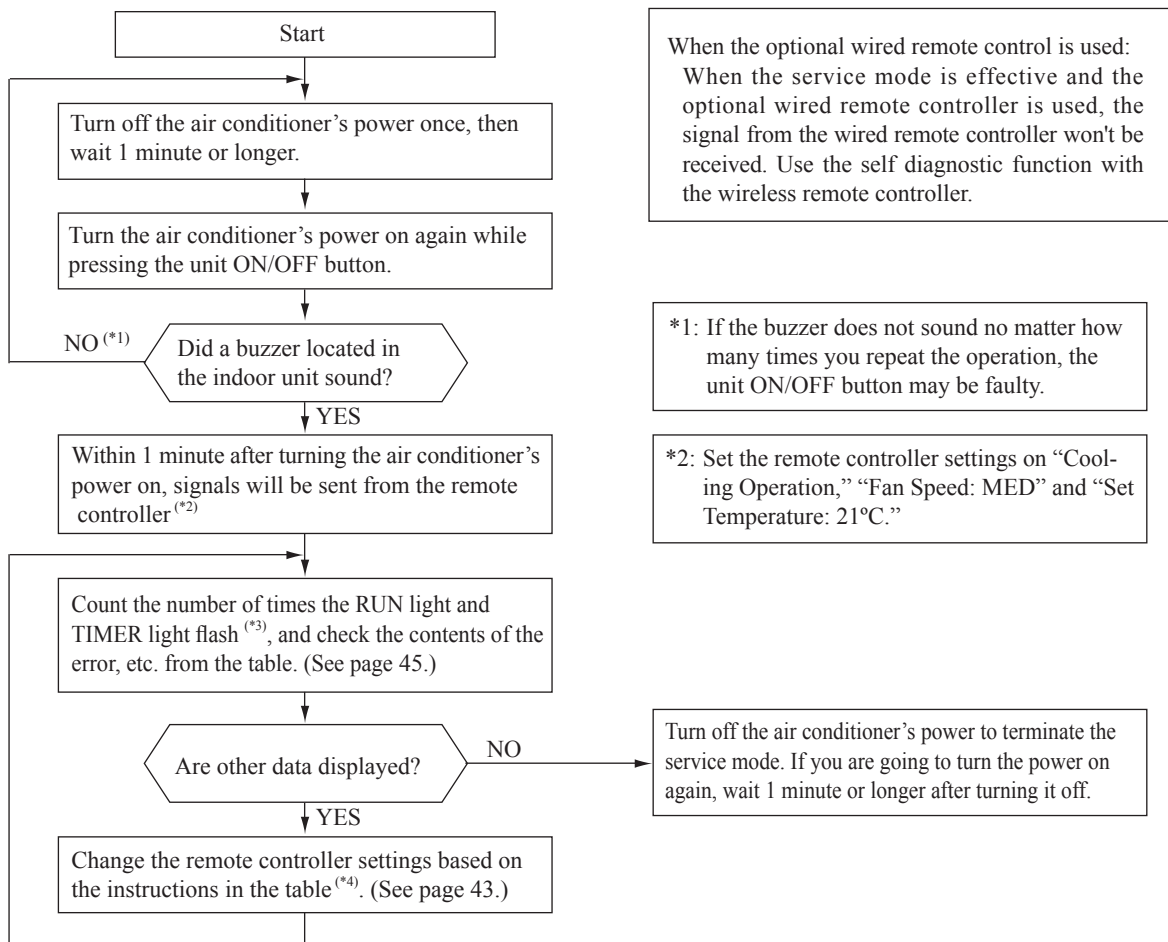

*3: To count the number of flashes in the service mode, count the number of flashes after the light lights up for 1.5 second initially (start signal). (The time that the light lights up for 1.5 second (start signal) is not counted in the number of flashes.)

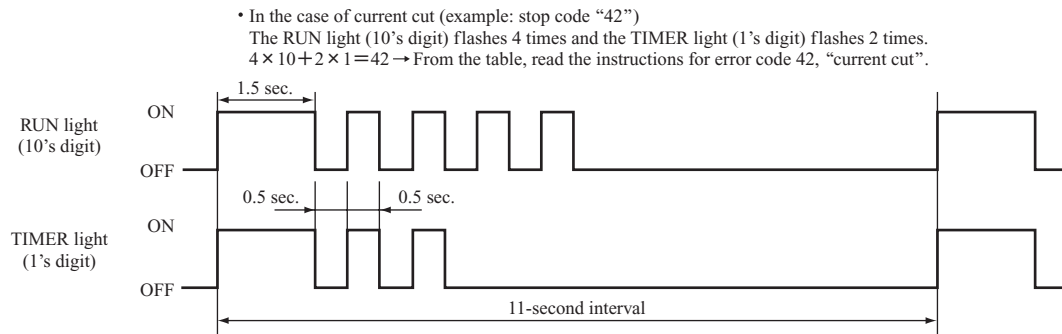

*4: When in the service mode, when the remote controller settings (operation switching, fan speed switching, temperature setting) are set as shown in the following table and sent to the air conditioner unit, the unit switches to display of service data.

1) Self-diagnosis data

What are Self-.....These are control data (reasons for stops, temperature at each sensor, remote controller information) diagnosis Data? from the time when there were error displays (abnormal stops) in the indoor unit in the past.

Data from up to 5 previous occasions are stored in memory. Data older than the 5th previous occasion are erased.

The temperature setting indicates how many occasions previous to the present setting the error display data are and the operation switching and fan speed switching data show the type of data.

Remote controller setting		Contents of output data
Operation switching	Fan speed switching	
Cooling	MED	Displays the reason for stopping display in the past (error code).
	HI	Displays the room temperature sensor temperature at the time the error code was displayed in the past.
	AUTO	Displays the indoor heat exchanger sensor temperature at the time the error code was displayed in the past.
Heating	LO	Displays the remote controller information at the time the error code was displayed in the past.
	MED	Displays the outdoor air temperature sensor temperature at the time the error code was displayed in the past.
	HI	Displays the outdoor heat exchanger sensor temperature at the time the error code was displayed in the past.
	AUTO	Displays the discharge pipe sensor temperature at the time the error code was displayed in the past.

Remote controller setting	Indicates the number of occasions previous to the present the error display data are from.
Temperature setting	
21°C	1 time previous (previous time)
22°C	2 times previous
23°C	3 times previous
24°C	4 times previous
25°C	5 times previous

Only for indoor heat exchanger sensor 2

Remote controller setting	Indicates the number of occasions previous to the present the error display data are from.
Temperature setting	
26°C	1 time previous (previous time)
27°C	2 times previous
28°C	3 times previous
29°C	4 times previous
30°C	5 times previous

(Example)

Remote controller setting			Displayed data
Operation switching	Fan speed switching	Temperature setting	
Cooling	MED	21°C	Displays the reason for the stop (error code) the previous time an error was displayed.
		22°C	Displays the reason for the stop (error code) 2 times previous when an error was displayed.
		23°C	Displays the reason for the stop (error code) 3 times previous when an error was displayed.
		24°C	Displays the reason for the stop (error code) 4 times previous when an error was displayed.
		25°C	Displays the reason for the stop (error code) 5 times previous when an error was displayed.

2) Stop data

Remote controller setting			Displayed data
Operation switching	Fan speed switching	Temperature setting	
Cooling	LO	21°C	Displays the reason for the stop (stop code) the previous time when the air conditioner was stopped by protective stop control.
		22°C	Displays the reason for the stop (stop code) 2 times previous when the air conditioner was stopped by protective stop control.
		23°C	Displays the reason for the stop (stop code) 3 times previous when the air conditioner was stopped by protective stop control.
		24°C	Displays the reason for the stop (stop code) 4 times previous when the air conditioner was stopped by protective stop control.
		25°C	Displays the reason for the stop (stop code) 5 times previous when the air conditioner was stopped by protective stop control.
		26°C	Displays the reason for the stop (stop code) 6 times previous when the air conditioner was stopped by protective stop control.
		27°C	Displays the reason for the stop (stop code) 7 times previous when the air conditioner was stopped by protective stop control.
		28°C	Displays the reason for the stop (stop code) 8 times previous when the air conditioner was stopped by protective stop control.
		29°C	Displays the reason for the stop (stop code) 9 times previous when the air conditioner was stopped by protective stop control.
		30°C	Displays the reason for the stop (stop code) 10 times previous when the air conditioner was stopped by protective stop control.

(c) **Error code, stop code table** (Assignment of error codes and stop codes is done in common for all models.)

Number of flashes when in service mode		Stop code or Error code	Error content	Cause	Occurrence conditions	Error display	Auto recovery
RUN light (10's digit)	TIMER light (1's digit)						
OFF	OFF	0	Normal	—	—	—	—
	5 time flash	05	Can not receive signals for 35 seconds (if communications have recovered)	Power supply is faulty. Power supply cables and signal lines are improperly wired. Indoor or outdoor PCB are faulty.	When 35 seconds passes without communications signals from either the outdoor unit or the indoor unit being detected correctly.	○	—
3 time flash	5 time flash	35	Cooling high pressure control	Cooling overload operation. Outdoor unit fan speed drops. Outdoor heat exchanger sensor is short circuit.	When the outdoor heat exchanger sensor's value exceeds the set value.	○ (5 times)	○
	6 time flash	36	Compressor overheat 110°C	Refrigerant is insufficient. Discharge pipe sensor is faulty. Service valve is closed.	When the discharge pipe sensor's value exceeds the set value.	○ (2 times)	○
	7 time flash	37	Outdoor heat exchanger sensor is abnormal	Outdoor heat exchanger sensor wire is disconnected. Connector connections are poor. Outdoor PCB is faulty.	-55°C or lower is detected for 5 seconds continuously 3 times within 40 minutes after initial detection of this anomalous temperature. Or -55°C higher is detected for 5 seconds continuously within 20 seconds after compressor ON.	○ (3 times)	○
	8 time flash	38	Outdoor air temperature sensor is abnormal	Outdoor air temperature sensor wire is disconnected. Connector connections are poor. Outdoor PCB is faulty.	-55°C or lower is detected for 5 seconds continuously 3 times within 40 minutes after initial detection of this anomalous temperature. Or -55°C higher is detected for 5 seconds continuously within 20 seconds after compressor ON.	○ (3 times)	○
	9 time flash	39	Discharge pipe sensor is abnormal (anomalous stop)	Discharge pipe sensor wire is disconnected. Connector connections are poor. Outdoor PCB is faulty.	-25°C or lower is detected for 5 seconds continuously 3 times within 40 minutes after initial detection of this anomalous temperature.	○ (3 times)	○
4 time flash	2 time flash	42	Current cut	Compressor lock. Compressor wiring short circuit. Compressor output is open phase. Outdoor PCB is faulty. Service valve is closed. Electronic expansion valve is faulty. Compressor is faulty.	Compressor start fails 42 times in succession and the reason for the final failure is current cut.	○ (2 times)	○
	7 time flash	47	Active filter voltage error	Defective active filter.	When the wrong voltage connected for the power supply. When the outdoor PCB is faulty.	○	—
	8 time flash	48	Outdoor unit's fan motor is abnormal	Outdoor fan motor is faulty. Connector connections are poor. Outdoor PCB is faulty.	When a fan speed of 75 rpm or lower continues for 30 seconds or longer.	○ (3 times)	○
5 time flash	1 time flash	51	Short circuit in the power transistor (high side) Current cut circuit breakdown	Outdoor PCB is faulty. Power transistor is damaged.	When it is judged that the power transistor was damaged at the time the compressor started.	○	—
	3 time flash	53	Suction pipe sensor is abnormal (Multi system only)	Suction pipe sensor wire is disconnected. Connector connections are poor. Outdoor PCB is faulty.	-55°C or lower is detected for 5 seconds continuously 3 times within 40 minutes after initial detection of this anomalous temperature. Or -55°C higher is detected for 5 seconds continuously within 20 seconds after compressor ON.	○ (3 times)	○
	7 time flash	57	Refrigeration cycle system protective control	Service valve is closed. Refrigerant is insufficient.	When refrigeration cycle system protective control operates.	○ (3 times)	○
	8 time flash	58	Current safe	Refrigerant is overcharge. Compressor lock. Overload operation.	When there is a current safe stop during operation.	—	○
	9 time flash	59	Compressor wiring is unconnection Voltage drop Low speed protective control	Compressor wiring is disconnected. Power transistor is damaged. Power supply construction is defective. Outdoor PCB is faulty. Compressor is faulty.	When the current is 1A or less at the time the compressor started. When the power supply voltage drops during operation. When the outdoor unit's speed is lower than 32 rps for 60 minutes.	○	○
6 time flash	OFF	60	Rotor lock	Compressor is faulty. Compressor output is open phase. Electronic expansion valve is faulty. Overload operation. Outdoor PCB is faulty.	After the compressor starts, when the compressor stops due to rotor lock.	○ (2 times)	○
	1 time flash	61	Connection lines between the indoor and outdoor units are faulty	Connection lines are faulty. Indoor or outdoor PCB are faulty.	When 10 seconds passes after the power is turned on without communications signals from the indoor or outdoor unit being detected correctly.	○	—
	2 time flash	62	Serial transmission error	Indoor or outdoor PCB are faulty. Noise is causing faulty operation.	When 7 minute 35 seconds passes without communications signals from either the outdoor unit or the indoor unit being detected correctly.	○	—
8 time flash	OFF	80	Indoor unit's fan motor is abnormal	Indoor fan motor is faulty. Connector connections are poor. Indoor PCB is faulty.	When the indoor unit's fan motor is detected to be running at 300 rpm or lower speed with the fan motor in the ON condition while the air conditioner is running.	○	—
	2 time flash	82	Indoor heat exchanger sensor is abnormal (anomalous stop)	Indoor heat exchanger sensor wire is disconnected. Connector connections are poor.	When a temperature of -28°C or lower is sensed continuously for 40 minutes during heating operation. (the compressor stops).	○	—
	4 time flash	84	Anti-condensation control	High humidity condition. Humidity sensor is faulty.	Anti-condensation prevention control is operating.	—	○
	5 time flash	85	Anti-frost control	Indoor unit fan speed drops. Indoor heat exchanger sensor is broken wire.	When the anti-frost control operates and the compressor stops during cooling operation.	—	○
	6 time flash	86	Heating high pressure control	Heating overload operation. Indoor unit fan speed drops. Indoor heat exchanger sensor is short circuit.	When high pressure control operates during heating operation and the compressor stops.	—	○

Note (1) The number of flashes when in the Service Mode do not include the 1.5 second period when the lights light up at first (starting signal). (See the example shown below.)

• In the case of current cut (example: stop code "42")
 The RUN light (10's digit) flashes 4 times and the TIMER light (1's digit) flashes 2 times.
 $4 \times 10 + 2 \times 1 = 42 \rightarrow$ From the table, read the instructions for error code 42, "current cut".

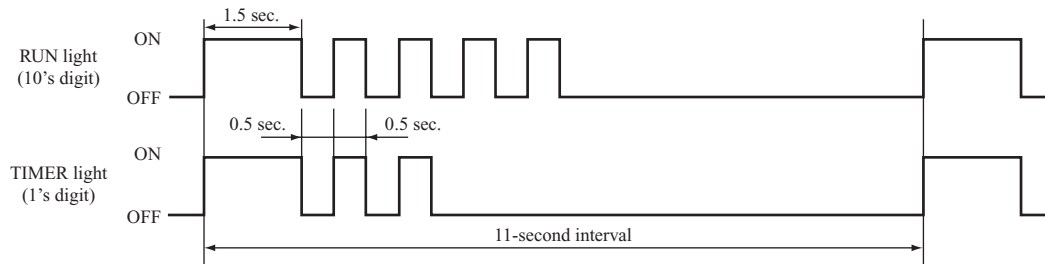

- (2) Error display:
 – Is not displayed. (automatic recovery only)
 Displayed.
 If there is a () displayed, the error display shows the number of times that an auto recovery occurred for the same reason has reached the number of times in ().
 If no () is displayed, the error display shows that the trouble has occurred once.
- (3) Auto Recovery:
 – Does not occur
 Auto recovery occurs.

(d) Remote controller information tables

1) Operation switching

Display pattern when in service mode RUN light (Operation switching)	Operation switching when there is an abnormal stop
0	AUTO
1	DRY
2	COOL
3	FAN
4	HEAT

2) Fan speed switching

Display pattern when in service mode TIMER light (Fan speed switching)	Fan speed switching when there is an abnormal stop
0	AUTO
2	HI
3	MED
4	LO
6	HI POWER
7	ECONO

* If no data are recorded (error code is normal), the information display in the remote controller becomes as follows.

Remote controller setting	Display when error code is normal.
Operation switching	AUTO
Fan speed switching	AUTO

(Example): Operation switching, fan speed switching, cooling HI

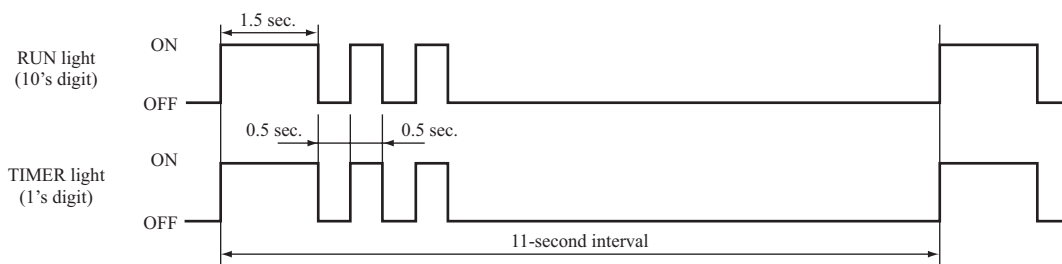

(e) Room temperature sensor, indoor heat exchanger sensor, outdoor air temperature sensor, outdoor heat exchanger sensor table

Units: °C

Buzzer sound	RUN light (10's digit)	TIMER light (1's digit)										
		0	1	2	3	4	5	6	7	8	9	
Yes (sounds for 0.1 second)	6	-60	-61	-62	-63	-64						
	5	-50	-51	-52	-53	-54	-55	-56	-57	-58	-59	
	4	-40	-41	-42	-43	-44	-45	-46	-47	-48	-49	
	3	-30	-31	-32	-33	-34	-35	-36	-37	-38	-39	
	2	-20	-21	-22	-23	-24	-25	-26	-27	-28	-29	
	1	-10	-11	-12	-13	-14	-15	-16	-17	-18	-19	
	0	/	-1	-2	-3	-4	-5	-6	-7	-8	-9	
No (does not sound)	0	0	1	2	3	4	5	6	7	8	9	
	1	10	11	12	13	14	15	16	17	18	19	
	2	20	21	22	23	24	25	26	27	28	29	
	3	30	31	32	33	34	35	36	37	38	39	
	4	40	41	42	43	44	45	46	47	48	49	
	5	50	51	52	53	54	55	56	57	58	59	
	6	60	61	62	63	64	65	66	67	68	69	
	7	70	71	72	73	74	75	76	77	78	79	
	8	80	81	82	83	84	85	86	87	88	89	
	9	90	91	92	93	94	95	96	97	98	99	

* If no data are recorded (error code is normal), the display for each sensor becomes as shown below.

Sensor name	Sensor value displayed when the error code is normal
Room temperature sensor	-64°C
Indoor heat exchanger sensor	-64°C
Outdoor air temperature sensor	-64°C
Outdoor heat exchanger sensor	-64°C

(Example) Room temperature, indoor heat exchanger, outdoor air temperature, outdoor heat exchanger: “-9°C”

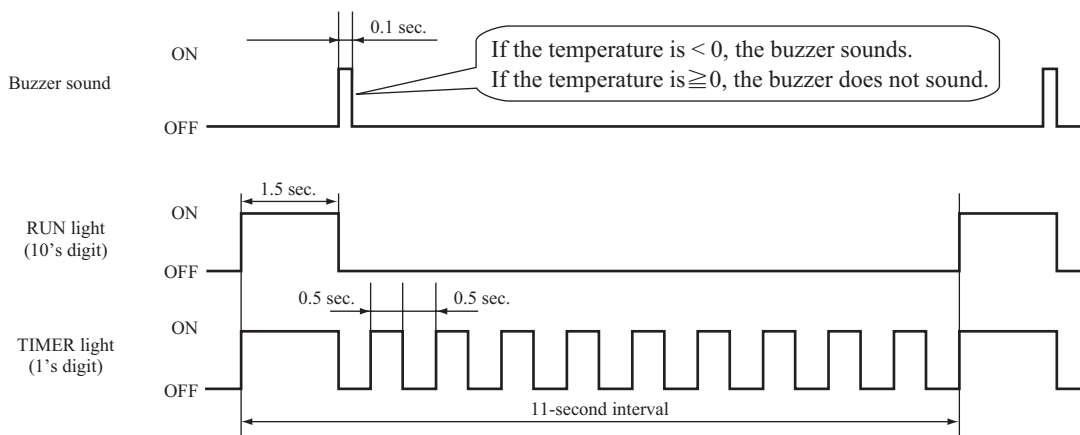

(f) Discharge pipe sensor table

Units: °C

Buzzer sound	RUN light (10's digit)	TIMER light (1's digit)										
		0	1	2	3	4	5	6	7	8	9	
Yes (sounds for 0.1 second)	3	-60	-62	-64								
	2	-40	-42	-44	-46	-48	-50	-52	-54	-56	-58	
	1	-20	-22	-24	-26	-28	-30	-32	-34	-36	-38	
	0	/	-2	-4	-6	-8	-10	-12	-14	-16	-18	
No (does not sound)	0	0	2	4	6	8	10	12	14	16	18	
	1	20	22	24	26	28	30	32	34	36	38	
	2	40	42	44	46	48	50	52	54	56	58	
	3	60	62	64	66	68	70	72	74	76	78	
	4	80	82	84	86	88	90	92	94	96	98	
	5	100	102	104	106	108	110	112	114	116	118	
	6	120	122	124	126	128	130	132	134	136	138	
	7	140	142	144	146	148	150					

* If no data are recorded (error code is normal), the display for each sensor becomes as shown below.

Sensor name	Sensor value displayed when the error code is normal
Discharge pipe sensor	-64°C

(Example) Discharge pipe temperature: "122°C"

* In the case of discharge pipe data, multiply the reading value by 2. (Below, 61 x 2 = "122°C")

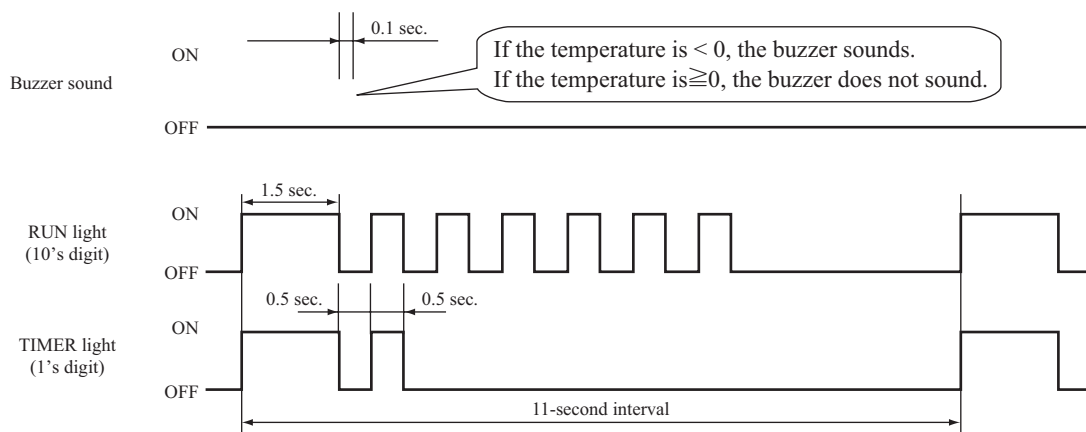

Service data record form

Customer				Model			
Date of investigation							
Machine name							
Content of complaint							
Remote controller settings			Content of displayed data	Display results			Display content
Temperature setting	Operation switching	Fan speed switching		Buzzer (Yes/No.)	RUN light (Times)	TIMER light (Times)	
21	Cooling	MED	Error code on previous occasion.	/			
		HI	Room temperature sensor on previous occasion.				
		AUTO	Indoor heat exchanger sensor 1 on previous occasion.				
	Heating	LO	Remote controller information on previous occasion.	/			
		MED	Outdoor air temperature sensor on previous occasion.				
		HI	Outdoor heat exchanger sensor on previous occasion.				
	AUTO	Discharge pipe sensor on previous occasion.					
26	Cooling	AUTO	Indoor heat exchanger sensor 2 on previous occasion.				
22	Cooling	MED	Error code on second previous occasion.	/			
		HI	Room temperature sensor on second previous occasion.				
		AUTO	Indoor heat exchanger sensor 1 on second previous occasion.				
	Heating	LO	Remote controller information on second previous occasion.	/			
		MED	Outdoor air temperature sensor on second previous occasion.				
		HI	Outdoor heat exchanger sensor on second previous occasion.				
	AUTO	Discharge pipe sensor on second previous occasion.					
27	Cooling	AUTO	Indoor heat exchanger sensor 2 on second occasion.				
23	Cooling	MED	Error code on third previous occasion.	/			
		HI	Room temperature sensor on third previous occasion.				
		AUTO	Indoor heat exchanger sensor 1 on third previous occasion.				
	Heating	LO	Remote controller information on third previous occasion.	/			
		MED	Outdoor air temperature sensor on third previous occasion.				
		HI	Outdoor heat exchanger sensor on third previous occasion.				
	AUTO	Discharge pipe sensor on third previous occasion.					
28	Cooling	AUTO	Indoor heat exchanger sensor 2 on third occasion.				
24	Cooling	MED	Error code on fourth previous occasion.	/			
		HI	Room temperature sensor on fourth previous occasion.				
		AUTO	Indoor heat exchanger sensor 1 on fourth previous occasion.				
	Heating	LO	Remote controller information on fourth previous occasion.	/			
		MED	Outdoor air temperature sensor on fourth previous occasion.				
		HI	Outdoor heat exchanger sensor on fourth previous occasion.				
	AUTO	Discharge pipe sensor on fourth previous occasion.					
29	Cooling	AUTO	Indoor heat exchanger sensor 2 on fourth occasion.				
25	Cooling	MED	Error code on fifth previous occasion.	/			
		HI	Room temperature sensor on fifth previous occasion.				
		AUTO	Indoor heat exchanger sensor 1 on fifth previous occasion.				
	Heating	LO	Remote controller information on fifth previous occasion.	/			
		MED	Outdoor air temperature sensor on fifth previous occasion.				
		HI	Outdoor heat exchanger sensor on fifth previous occasion.				
	AUTO	Discharge pipe sensor on fifth previous occasion.					
30	Cooling	AUTO	Indoor heat exchanger sensor 2 on fifth occasion.				
21	Cooling	Lo	Stop code on previous occasion.				
22			Stop code on second previous occasion.				
23			Stop code on third previous occasion.				
24			Stop code on fourth previous occasion.				
25			Stop code on fifth previous occasion.				
26			Stop code on sixth previous occasion.				
27			Stop code on seventh previous occasion.				
28			Stop code on eighth previous occasion.				
29			Stop code on ninth previous occasion.				
30			Stop code on tenth previous occasion.				
Judgment							Examiner
Remarks							

Note (1) In the case of indoor heat exchanger sensor 2, match from 26 to 30 the temperature setting of remote controller. (Refer to page 43)

(7) Inspection procedures corresponding to detail of trouble

Sensor error

[Broken sensor wire, connector poor connection]

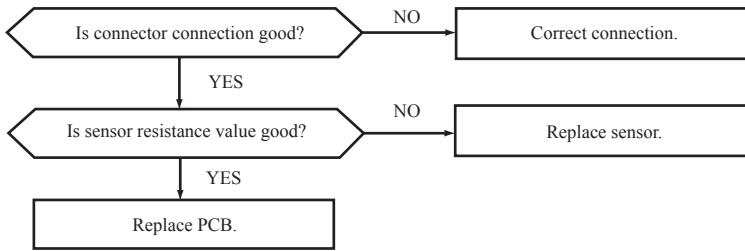

◆ Discharge pipe sensor temperature characteristics

◆ Sensor temperature characteristics (Room temp., indoor heat exchanger temp., outdoor heat exchanger temp., outdoor air temp.)

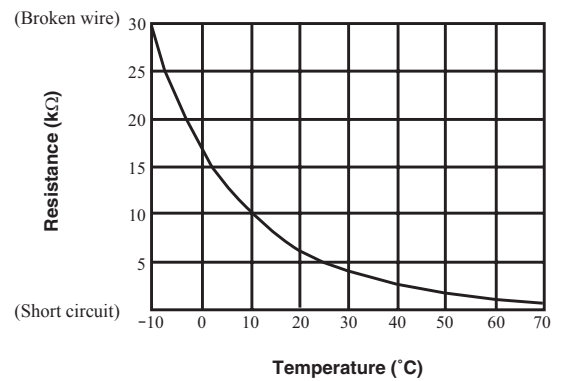
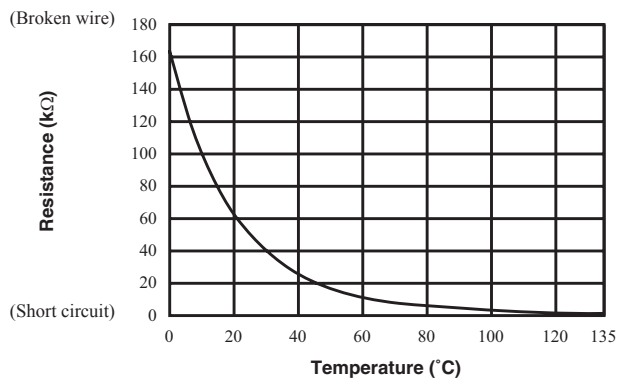

Indoor fan motor error

[Defective fan motor, connector poor connection, defective indoor PCB]

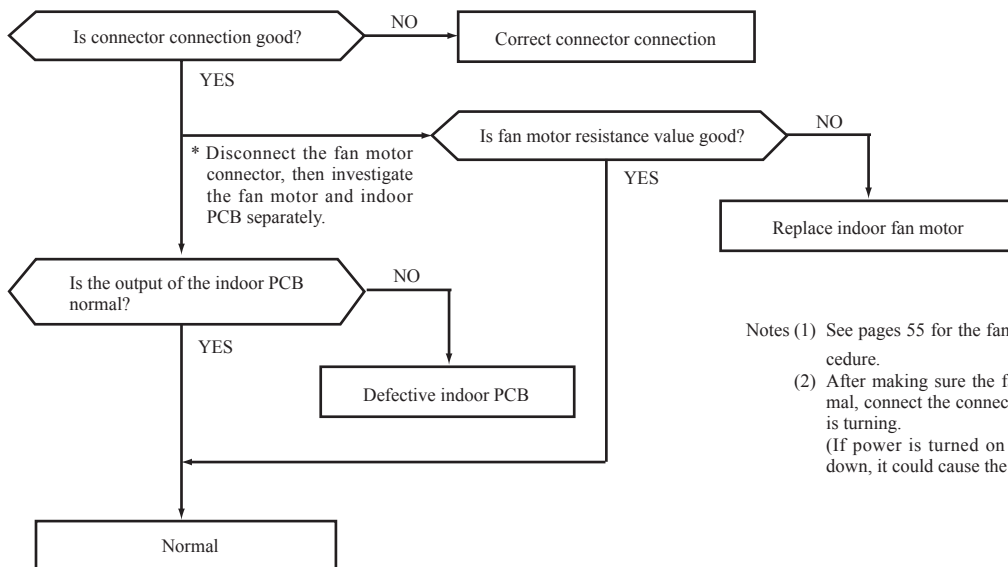

Notes (1) See pages 55 for the fan motor and indoor PCB check procedure.
 (2) After making sure the fan motor and indoor PCB are normal, connect the connectors and confirm that the fan motor is turning.
 (If power is turned on while one or the other is broken down, it could cause the other to break down also.)

Current cut

[Compressor lock, Compressor wiring short circuit, Compressor output is open phase, Outdoor PCB is faulty, Service valve is closed, EEV is faulty, Compressor faulty.]

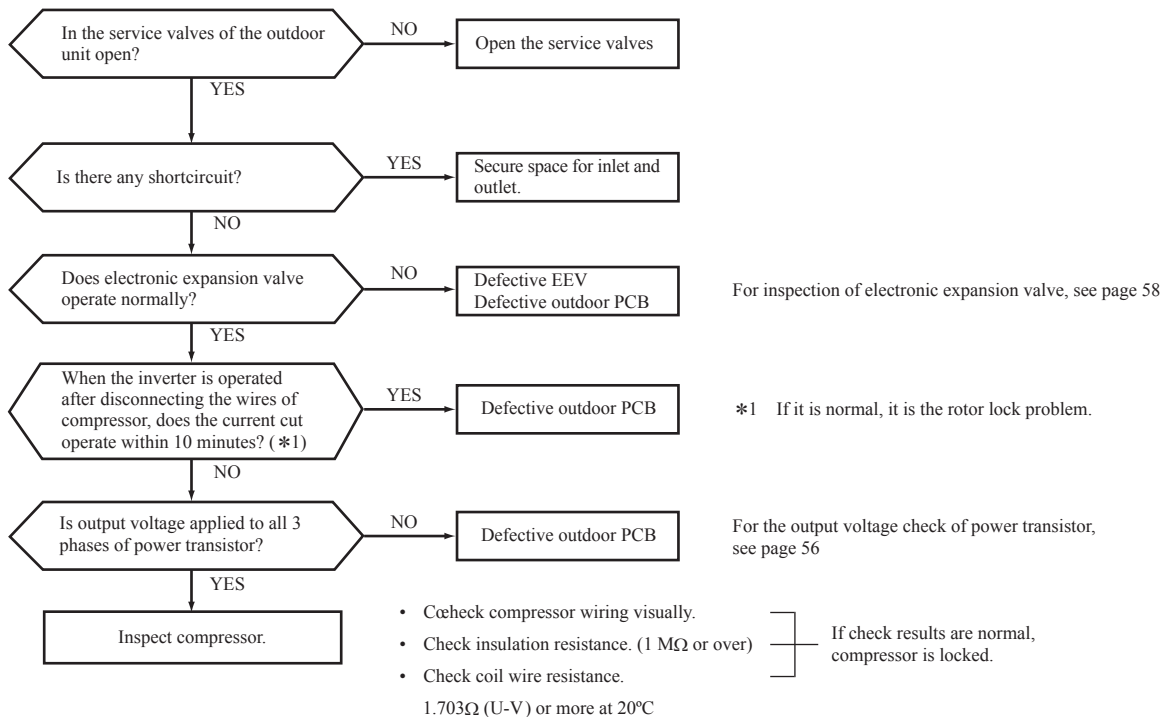

Current safe stop

[Overload operation, compressor lock, overcharge]

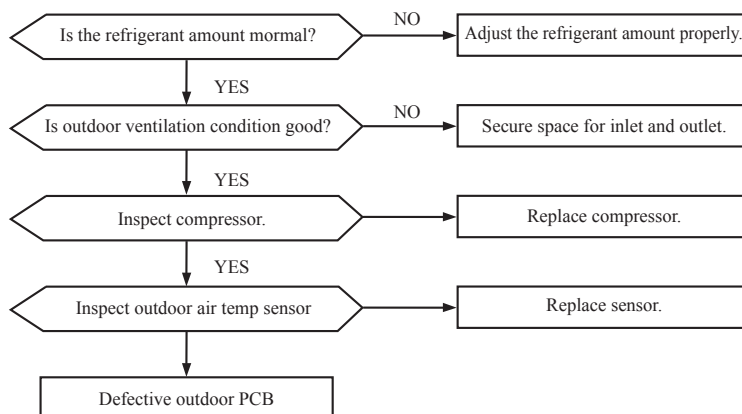

Over heat of compressor

[Gas shortage, defective discharge pipe sensor]

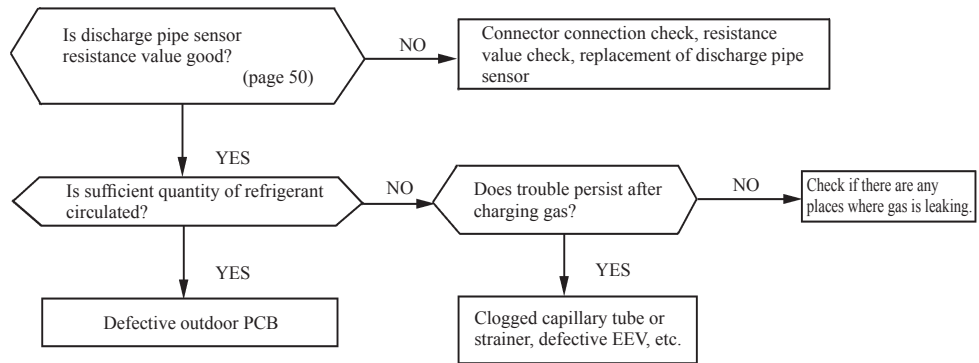

Error of signal transmission

[Wiring error including power cable, defective indoor/outdoor PCB]

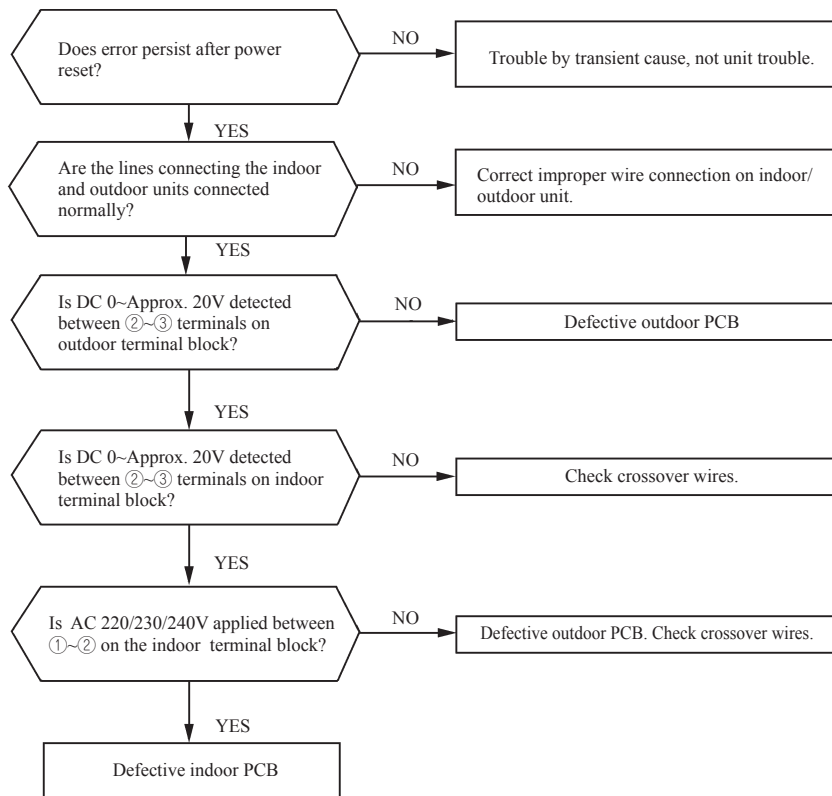

Trouble of outdoor unit

[Insufficient refrigerant amount, Faulty power transistor, Broken compressor wire]
 [Service valve close, Defective EEV, Defective outdoor PCB]

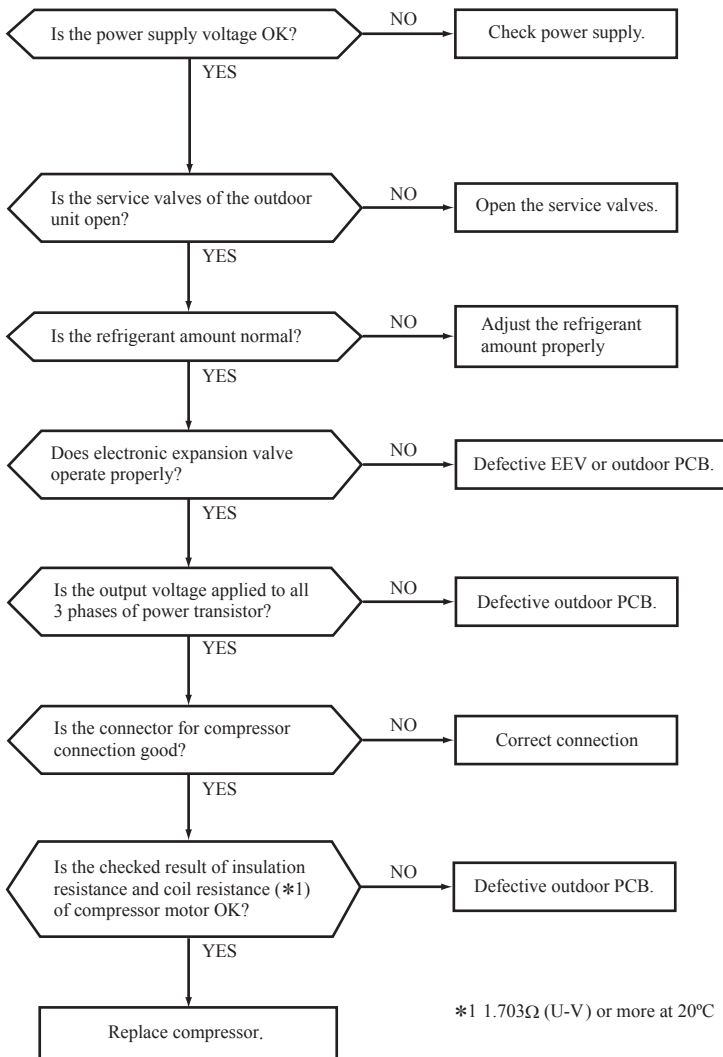

Proper power supply voltages are as follows.
 (At the power supply outlet)
 220V : 198~242V
 230V : 207~253V
 240V : 216~264V

- ◆ Judgment of refrigerant quantity
- (1) Phenomenon of insufficient refrigerant
 - (a) Loss of capacity
 - (b) Poor defrosting
(Frost is not removed completely.)
 - (c) Longer time of hot keep
(5 minute or more)
(Normal time: Approx. 1 – 1 minute and 30 seconds)

For inspection of electronic expansion valve, see page 58

For the output voltage check of power transistor, see page 56

*1 1.703Ω (U-V) or more at 20°C

Outdoor fan motor error

[Defective fan motor, connector poor connection, defective outdoor PCB]

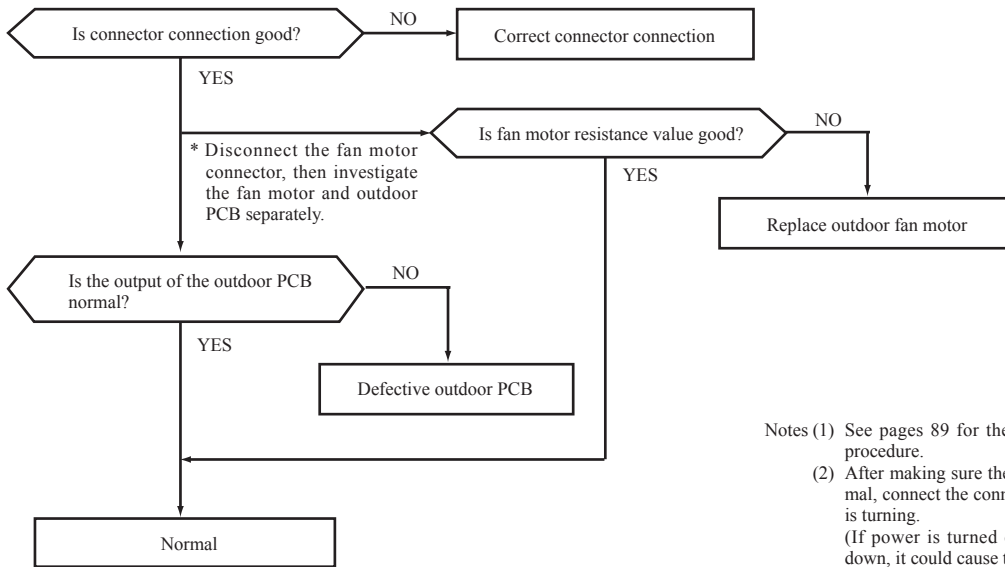

Notes (1) See pages 89 for the fan motor and outdoor PCB check procedure.
 (2) After making sure the fan motor and outdoor PCB are normal, connect the connectors and confirm that the fan motor is turning.
 (If power is turned on while one or the other is broken down, it could cause the other to break down also.)

Rotor lock

[Defective compressor, defective outdoor PCB]

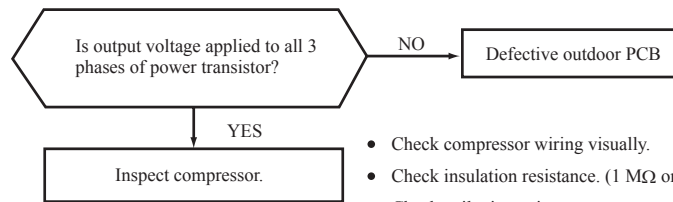

- Check compressor wiring visually.
 - Check insulation resistance. (1 MΩ or over)
 - Check coil wire resistance.
- 1.703Ω (U-V) or more at 20°C

⌋ If check results are normal, compressor is locked.

(8) Phenomenon observed after shortcircuit, wire breakage on sensor

(a) Indoor unit

Sensor	Operation mode	Phenomenon	
		Shortcircuit	Disconnected wire
Room temperature sensor	Cooling	Release of continuous compressor operation command.	Continuous compressor operation command is not released.
	Heating	Continuous compressor operation command is not released.	Release of continuous compressor operation command.
Heat exchanger sensor	Cooling	System can be operated normally.	Continuous compressor operation command is not released. (Anti-frosting)
	Heating	High pressure control mode (Compressor stop command)	Hot keep (Indoor fan stop)
Humidity sensor (35 model only)	Cooling	Refer to the table below.	Refer to the table below.
	Heating	Normal system operation is possible.	

■ Humidity sensor operation

Failure mode	Control input circuit resding	Air conditioning system operation
Disconnected wire	① Disconnected wire	Humidity reading is 0%
	② Disconnected wire	
	①② Disconnected wire	
Short Circuit	① and ② are shot circuited	Humidity reading is 100%

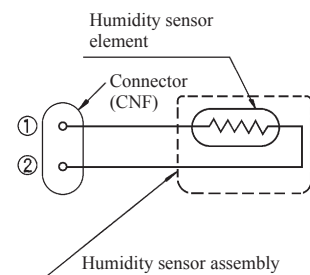

Remark: Do not perform a continuity check of the humidity sensor with a tester. If DC current is applied, it could damage the sensor.

(b) Outdoor unit

Sensor	Operation mode	Phenomenon	
		Shortcircuit	Disconnected wire
Heat exchanger sensor	Cooling	System can be operated normally.	Compressor stop.
	Heating	Defrosting is not performed.	Defrosting is performed for 10 minutes at approx. 45 minutes.
Outdoor air temperature sensor	Cooling	System can be operated normally.	Compressor stop.
	Heating	Defrosting is not operated.	Defrosting is performed for 10 minutes at approx. 45 minutes.
Discharge pipe sensor	All modes	Compressor overload protection is disabled. (Can be operated.)	Compressor stop

(9) Checking the indoor electrical equipment

(a) Indoor PCB check procedure

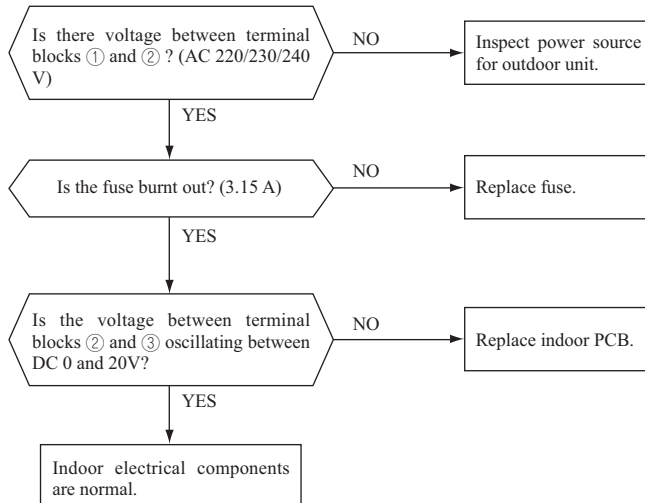

(b) Indoor unit fan motor check procedure

This is a diagnostic procedure for determining if the indoor unit's fan motor or the indoor PCB is broken down.

1) Indoor PCB output check

- a) Turn off the power.
- b) Remove the front panel, then disconnect the fan motor lead wire connector.
- c) Turn on the power. If the unit operates when the ON/OFF button is pressed, if trouble is detected after the voltages in the following figure are output for approximately 30 seconds, it means that the indoor PCB is normal and the fan motor is broken down.

If the voltages in the following figure are not output at connector pins No. ①, ④ and ⑤, the indoor PCB has failed and the fan motor is normal.

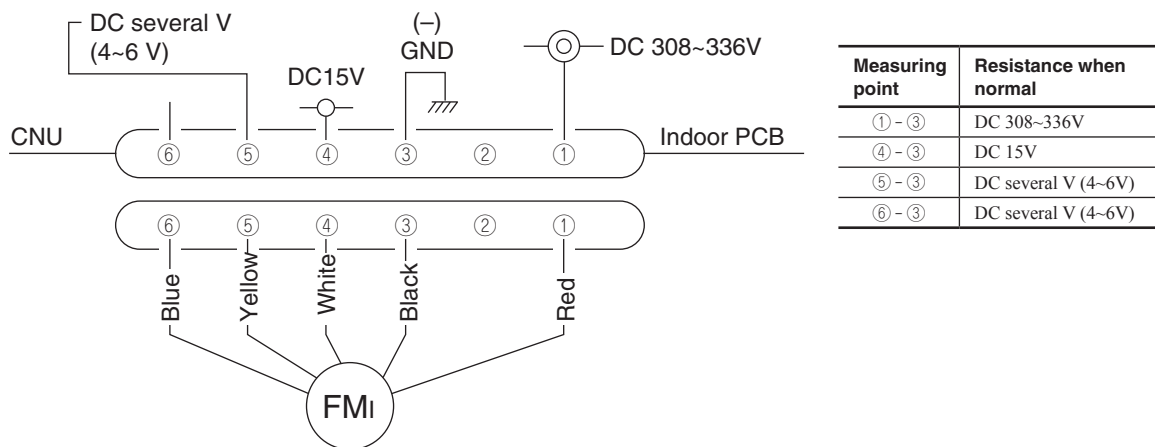

2) Fan motor resistance check

Measuring point	Resistance when normal
① - ③ (Red - Black)	20 MΩ or higher
④ - ③ (White - Black)	20 MΩ or higher

- Notes (1) Remove the fan motor and measure it without power connected to it.
 (2) If the measured value is below the value when the motor is normal, it means that the fan motor is faulty.

(C) Power transistor inspection procedure

[Use a tester with a needle indicator for the inspection. (Do not use a digital tester. Check in the AC 300 volt range.)]

(1) If there is a self-diagnosis display, inspect the compressor system (burns, wiring mistakes, etc.) If no problems are found, check the output of the power transistor.

(2) Output inspection procedure

Disconnect the terminals for the compressor.

If an output such as the one shown in the figure on the below can be measured, the power transistor and the circuit board for the outdoor unit are normal.

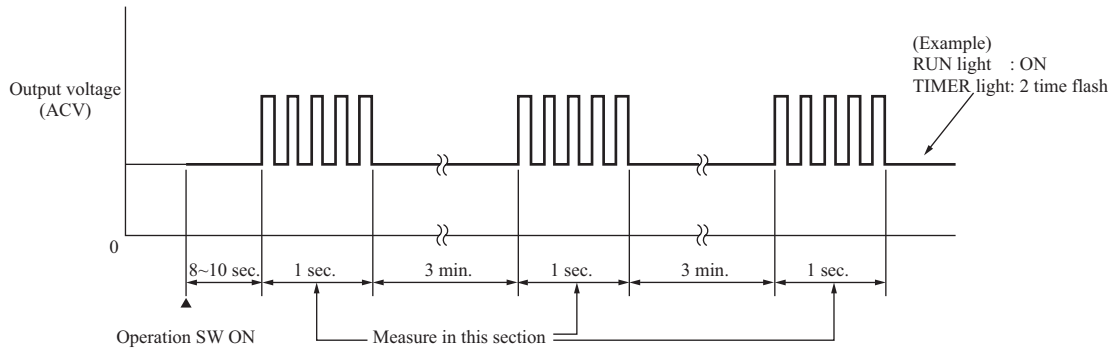

(10) How to make sure of remote controller

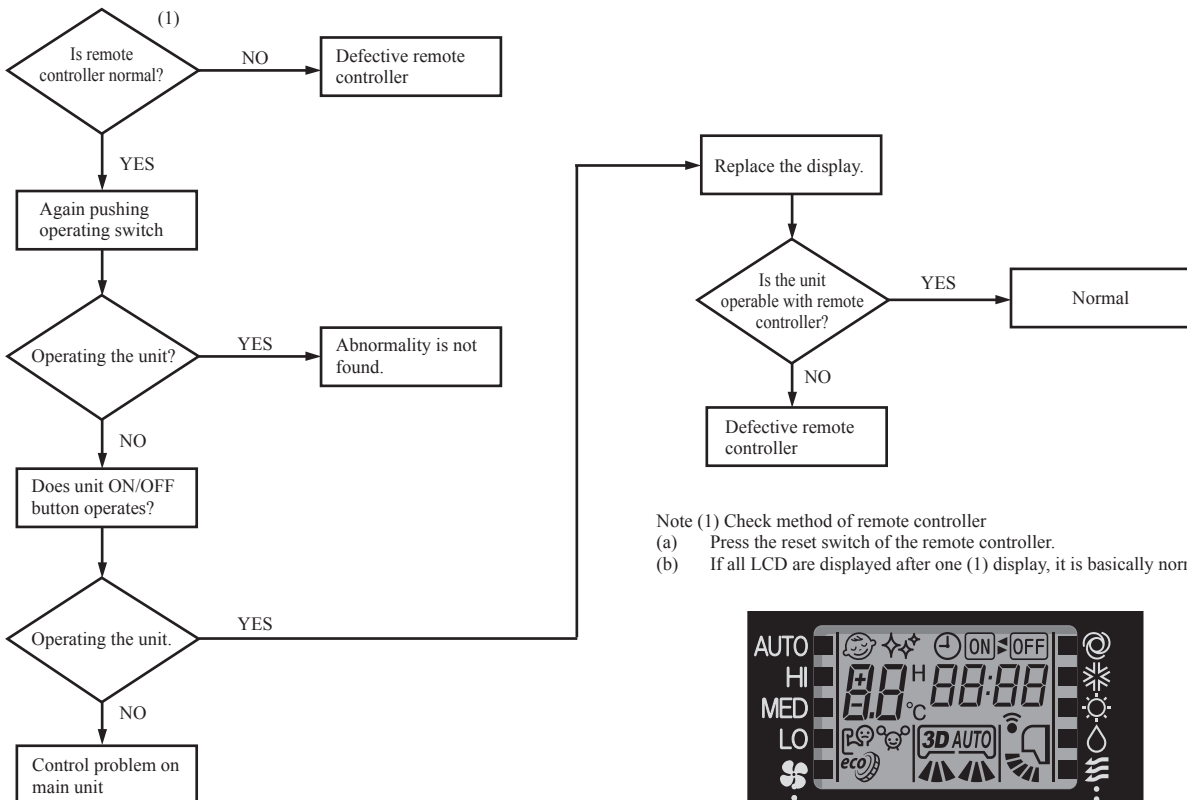

Note (1) Check method of remote controller
 (a) Press the reset switch of the remote controller.
 (b) If all LCD are displayed after one (1) display, it is basically normal.

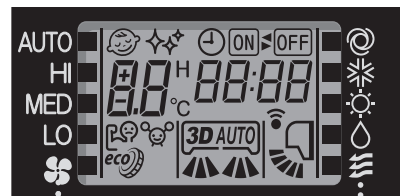

⚠ CAUTION – HIGH VOLTAGE

High voltage is produced in the control box. Don't touch electrical parts in the control box for 5 minutes after the unit is stopped.

Color symbol

BK	Black
OR	Orange
RD	Red
WH	White
Y	Yellow
Y/G	Yellow/Green

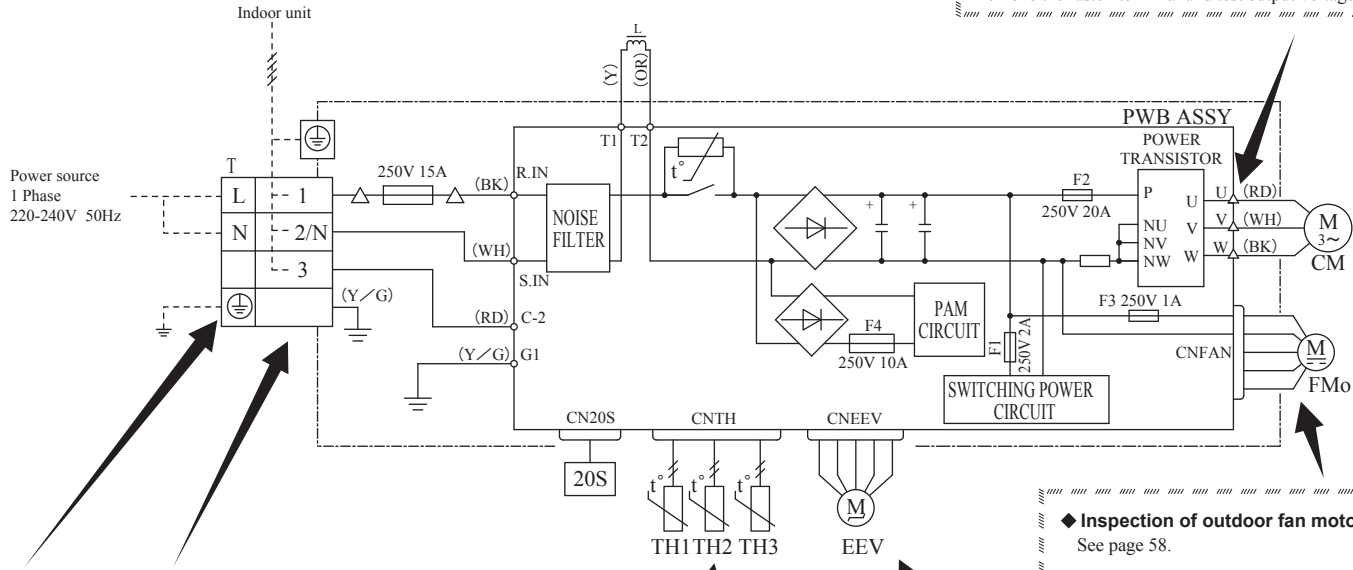

◆ **Inspection power transistor**
Remove the fasten terminal and test output voltage

◆ **Inspection of outdoor fan motor**
See page 58.

◆ **Inspection of electronic expansion valve**
See page 58.

◆ **Inspection of resistance value of sensor**
Remove the connector and check the resistance value.
See the section of sensor characteristics on page 50.

◆ **Power source and serial signal inspection**
① to ④: AC 220/230/240V
① to ②: AC 220/230/240V
② to ③: Normal if the voltage oscillates between DC 0 and approx. 20V

(11) Outdoor unit inspection points
Models SRC20ZJ-S, 25ZJ-S, 35ZJ-S

(a) Inspection of electronic expansion valve

Electronic expansion valve operates for approx. 10 seconds after the power on, in order to determine its aperture. Check the operating sound and voltage during the period of time. (Voltage cannot be checked during operation in which only the aperture change occurs.)

- 1) If it is heard the sound of operating electronic expansion valve, it is almost normal.
- 2) If the operating sound is not heard, check the output voltage.

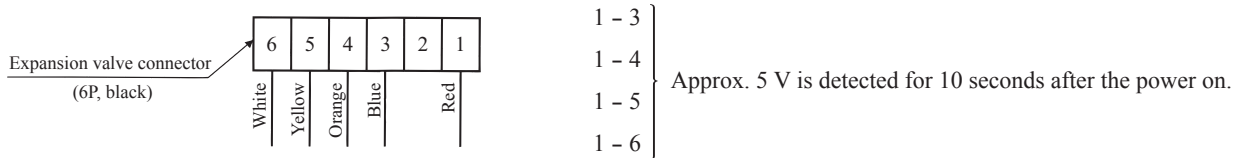

- 3) If voltage is detected, the outdoor PCB is normal.
- 4) If the expansion valve does not operate (no operating sound) while voltage is detected, the expansion valve is defective.

• Inspection of electronic expansion valve as a separate unit

Measure the resistance between terminals with an analog tester.

Measuring point	Resistance when normal
1-6	46 ± 4Ω (at 20°C)
1-4	
1-3	
1-5	

(b) Outdoor unit fan motor check procedure

- When the outdoor unit fan motor error is detected, diagnose which of the outdoor unit fan motor or outdoor PCB is defective.
- Diagnose this only after confirming that the indoor unit is normal.

(1) Outdoor PCB output check

- 1) Turn off the power.
- 2) Disconnect the outdoor unit fan motor connector CNFAN.
- 3) When the indoor unit is operated by inserting the power supply plug and pressing (ON) the backup switch for more than 5 seconds, if the voltage of pin No. ② in the following figure is output for 30 seconds at 20 seconds after turning “ON” the backup switch, the outdoor PCB is normal but the fan motor is defective.

If the voltage is not detected, the outdoor PCB is defective but the fan motor is normal.

Note (1) The voltage is output 3 times repeatedly. If it is not detected, the indoor unit displays the error message.

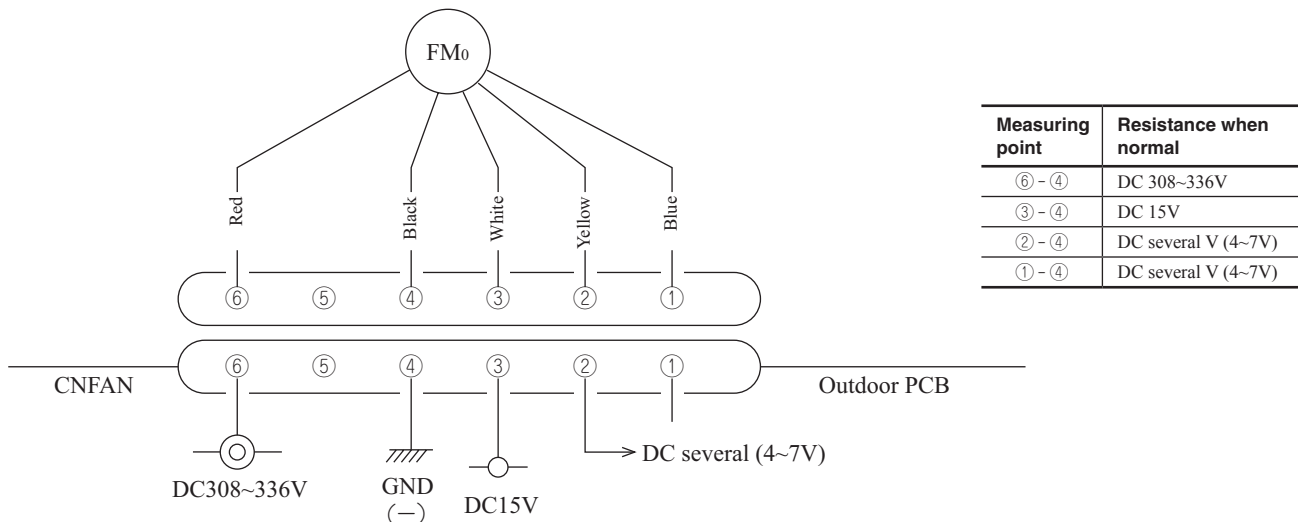

2) Fan motor resistance check

Measuring point	Resistance when normal
⑥ - ④ (Red - Black)	20 MΩ or higher
③ - ④ (White - Black)	20 MΩ or higher

- Notes (1) Remove the fan motor and measure it without power connected to it.
 (2) If the measured value is below the value when the motor is normal, it means that the fan motor is faulty.

INVERTER WALL MOUNTED TYPE ROOM AIR-CONDITIONERS



Air-Conditioning & Refrigeration Systems Headquarters
16-5, 2-chome, Kounan, Minato-ku, Tokyo, 108-8215, Japan
Fax : (03) 6716-5926

Because of our policy of continuous improvement, we reserve the right to make changes in all specifications without notice.